

Tolerância Geral: ± 5%

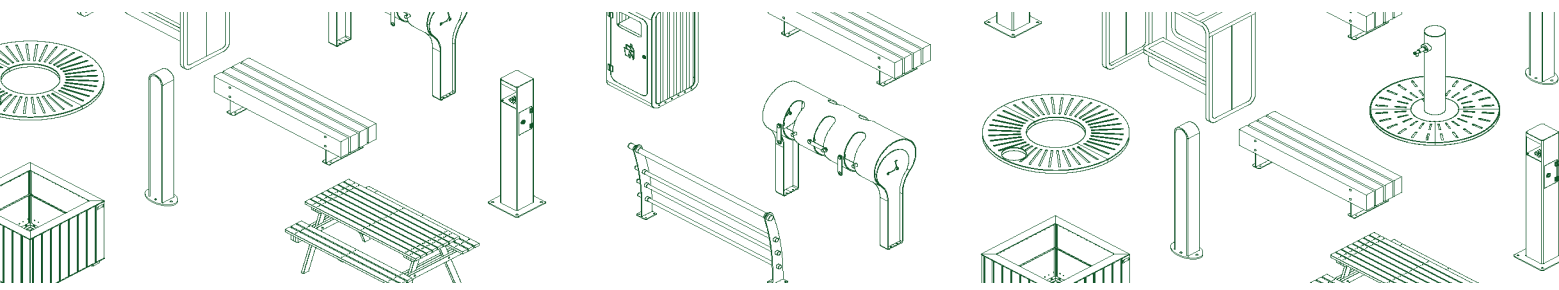

PORTUGAL
www.bragmaia.com
geral@bragmaia.com



brag
SPORT

brag
SIGN

brag
PLAY



brag
URBAN

brag
LIGHT

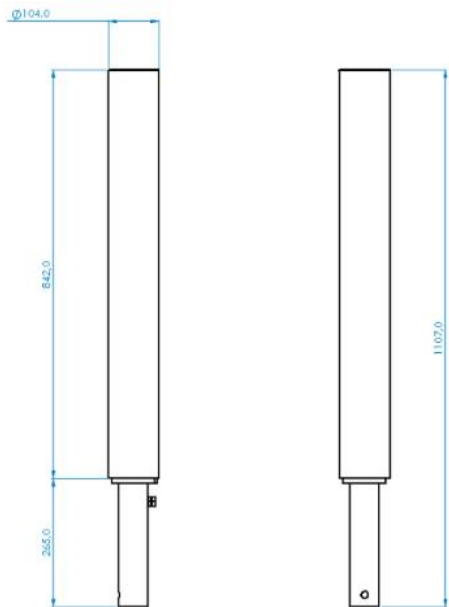
MEDIDAS GERAIS / MEDIDAS / MEASURES / MESURES



ACESSÓRIOS / ACCESORIOS / ACCESSORIES / ACCESSOIRES

- 1,0 x  271174 CHAVE TRIANGULAR P/FECHADURAS 200050/200050S
- 1,0 x  S500I SUPORTE EXTRAIVEL VARIO EM ACO INOX P/MARCOS SERIE C500



0,09m³



00:30h



1x



6,80kg



6,80kg

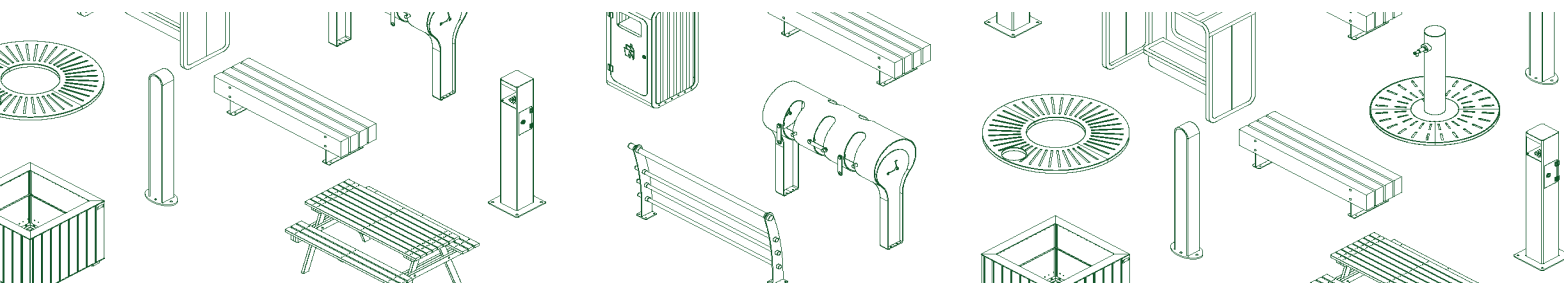



PORTUGAL
www.bragmaia.com
geral@bragmaia.com



brag **SPORT** brag **SIGN** brag **PLAY** brag **URBAN** brag **LIGHT**

VARIANTES / VARIANTES / VARIANTS / VARIANTES

	C502I316	MARCO LIMITADOR MONTEREALTUBO ACO INOX 316 DIAM.100MM C/1000MM ALT
	MAM1001000316E	MARCO LIMITADOR MONTEREALTUBO ACO INOX 316 EXTRAIVEL

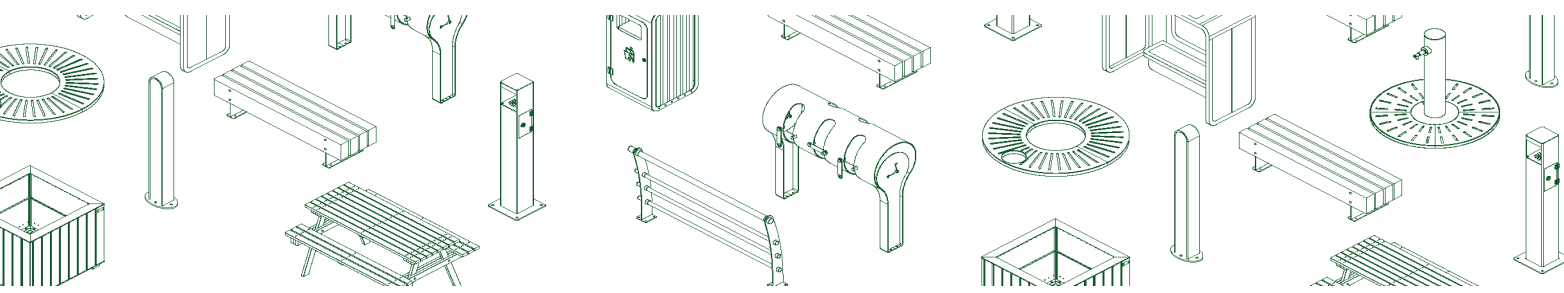

PORTUGAL
www.bragmaia.com
geral@bragmaia.com



brag
SPORT

brag
SIGN

brag
PLAY

brag
URBAN

brag
LIGHT

DESCRIÇÃO

Equipamento BragURBAN, marco limitador MONTREAL extraível, com estrutura em tubo Ø104mm em Inox 304. Fixação ao solo tipo Y (chumbar). Sendo que só 842mm estão acima do solo.

Medidas gerais (CxLxA): Ø104x1107mm

CARACTERÍSTICAS TÉCNICAS



TUBO AÇO INOX AISI 304

Tubo em aço inoxidável AISI 304, de acordo com a norma EN 14301, com acabamento 2B.
Garantia: 15 anos.



SISTEMA DE FIXAÇÃO

Tipo Y - Sistema de fixação composto por base metálica embutida ou por prumos aplicado diretamente no solo e chumbada com betão.

A base metálica embutida é fabricada em chapa de aço carbono, com tratamento anticorrosivo de galvanização por imersão a quente com espessura entre 120 a 140µm de acordo com a norma EN ISO 1461, que permite a sua colocação sem que o prumo entre em contacto direto com o solo. A sua fixação ao prumo é feita por um sistema de aperto rápido aumentando a longevidade do prumo e a sua fácil e rápida substituição em caso de necessidade.

CONFIDENCIALIDADE E PROPRIEDADE INTELECTUAL

A informação contida neste documento é confidencial, não podendo o destinatário do mesmo reproduzi-la ou permitir a terceiros que a obtenham, utilizem ou divulguem sem a prévia e expressa autorização da BRAGMAIA.

Todos os direitos de propriedade intelectual sobre os desenhos e modelos apresentados são da titularidade exclusiva da BRAGMAIA, sendo expressamente proibida a prática de qualquer ato de exploração dos mesmos sem o consentimento desta, nos termos do código da propriedade industrial e do código do direito de autor e dos direitos conexos. A violação da obrigação de confidencialidade e/ou dos direitos de propriedade intelectual da BRAGMAIA, pode dar origem a responsabilidade civil e criminal.

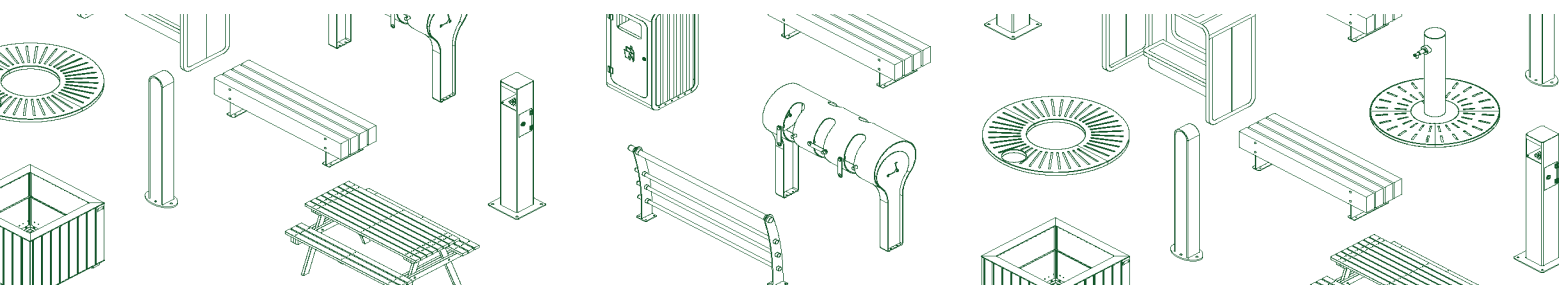

PORTUGAL
www.bragmaia.com
geral@bragmaia.com



brag
SPORT

brag
SIGN

brag
PLAY

brag
URBAN

brag
LIGHT



DESCRIPCIÓN

Equipamiento BragURBAN pilona "MONTREAL" extraíble, con estructura en tubo de Ø104mm en acero Inox 304. Fijación al suelo Tipo Y (hormigonado). Permanecen a la vista 842mm.

Medidas generales (LxAnxA): Ø104x1107mm

CARACTERÍSTICAS TÉCNICAS



TUBO ACERO INOX AISI 304

Tubo en acero inoxidable AISI 304, según la norma EN 14301, con refinamiento 2B. Garantía: 15 años.



SISTEMA DE FIJACIÓN

Tipo Y - Sistema de fijación estándar compuesto por una base metálica o poste embutido al suelo y con relleno de hormigón.

La base metálica incorporada está fabricada en chapa de acero de carbono, con tratamiento anticorrosivo por inmersión en caliente de 120 a 140µm de espesor según EN ISO 1461, que permite su colocación sin que el poste entre en contacto directo con el suelo. Su fijación a al poste se realiza por un sistema de sujeción rápido aumentando la longevidad del poste y su fácil y rápida sustitución en caso de necesidad.

CONFIDENCIALIDAD Y PROPIEDAD INTELECTUAL

La información contenida en este documento es estrictamente confidencial, no pudiendo el destinatario reproducirla o permitir a terceros que la adquieran, utilicen o divulguen sin la previa y expresa autorización de BRAGMAIA.

Todos los derechos de propiedad intelectual sobre los diseños y modelos presentados son de titularidad exclusiva de BRAGMAIA, estando expresamente prohibida la práctica de cualquier acto de usurpación de los mismos sin el previo consentimiento de la empresa, dentro de los términos del código de propiedad industrial y del código de derechos de autor y derechos análogos. La violación de la obligación de confidencialidad y/o de los derechos de propiedad intelectual de BRAGMAIA, puede dar origen a responsabilidad civil y criminal.

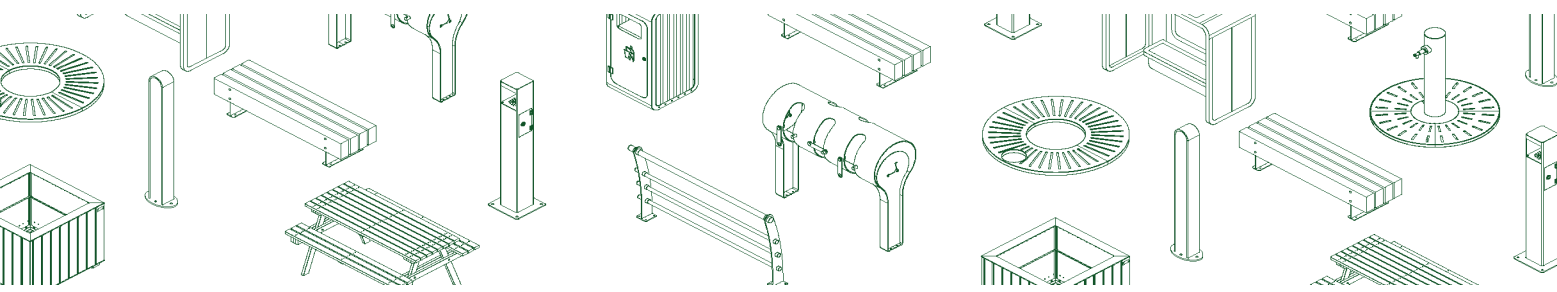

PORTUGAL
www.bragmaia.com
geral@bragmaia.com



brag
SPORT

brag
SIGN

brag
PLAY

brag
URBAN

brag
LIGHT



DESCRIPTION

BragURBAN equipment, MONTREAL removable bollard, with Ø104mm 304 stainless steel tube structure. Y-type ground fixing (in-ground). Only 842mm above the ground.

Dimensions (LxWxH): Ø104x1107mm

TECHNICAL FEATURES

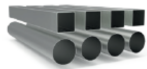

STAINLESS STEEL TUBE AISI 304

Tube in stainless steel AISI 304, according to EN 14301, with finish 2B.
Guarantee: 15 years.



FIXATION SYSTEM

Type Y - Fixation system composed of built-in metal base or plumbing applied directly to the ground and concrete sinker.

The built-in metal base is made of carbon steel sheet, with corrosion-resistant hot-dip galvanisation treatment of between 120 and 140µm thickness according to EN ISO 1461, which allows its placement without the plumb in direct contact with the ground. Its attachment to the plumb line is made by a quick clamping system increasing the longevity of the plumb line and its easy and fast replacement in case of need.

CONFIDENTIALITY AND INTELLECTUAL PROPERTY

The information contained in this document is confidential, and the recipient cannot reproduce it or allow third parties to obtain, use or disclose it without the prior and express authorization of BRAGMAIA.

All intellectual property rights over the designs and models presented are the exclusive property of BRAGMAIA, and the practice of any act of exploitation thereof without the consent of the latter, under the terms of the industrial property code and the copyright code and related rights. Violation of BRAGMAIA's obligation of confidentiality and / or intellectual property rights may give rise to civil and criminal liability.

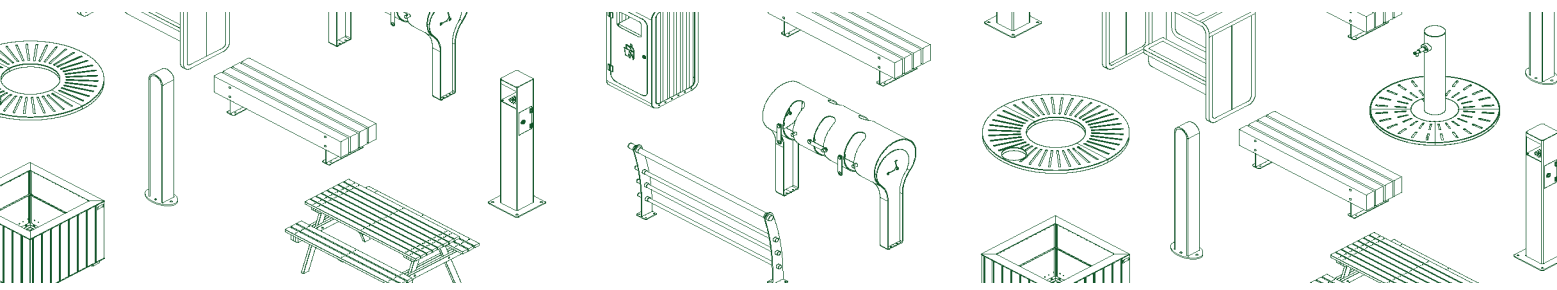

PORTUGAL
www.bragmaia.com
geral@bragmaia.com



brag **SPORT** brag **SIGN** brag **PLAY** brag **URBAN** brag **LIGHT**

DESCRIPTION

Équipement BragURBAN, borne amovible MONTREAL, avec structure en tube de Ø104mm en inox 304.
Fixation au sol de type Y (bétonner). Seulement 842mm au-dessus du sol.

Dimensions (Lxlxh): Ø104x1107mm

CARACTÉRISTIQUES TECHNIQUES



TUBE EN ACIER INOXYDABLE AISI 304

Tube en acier inoxydable AISI 304, en accord avec la norme EN 14301, avec finition 2B.
Garantie: 15 ans.



SISTÈME DE FIXATION

Type Y - Système de fixation composé d'une base métallique encastrée ou d'une poutre appliquée directement au sol et bétonnée.

La base métallique encastrée est fabriquée en tôle d'acier carbone, avec un traitement anticorrosion par galvanisation par immersion à chaud d'une épaisseur comprise entre 120 et 140µm selon la norme EN ISO 1461, qui permet sa pose sans que la poutre rentre en contact direct avec le sol. Sa fixation à la poutre est réalisée par un système de serrage rapide augmentant sa longévité et facilitant son remplacement, qui sera rapide en cas de besoin.

CONFIDENTIALITÉ ET PROPRIÉTÉ INTELLECTUELLE

Les informations contenues dans ce document sont confidentielles et le destinataire ne peut pas les reproduire ni permettre à des tiers de les obtenir, de les utiliser ou de les divulguer sans l'autorisation préalable et expresse de BRAGMAIA.

Tous les droits de propriété intellectuelle sur les dessins et modèles présentés sont propriété exclusive de BRAGMAIA, et la pratique d'un acte d'exploitation de ceux-ci sans le consentement de cette dernière, selon les termes du code de la propriété industrielle et du code du droit d'auteur et des droits voisins. La violation de l'obligation de confidentialité et / ou des droits de propriété intellectuelle de BRAGMAIA peut engager à la responsabilité civile et pénale.

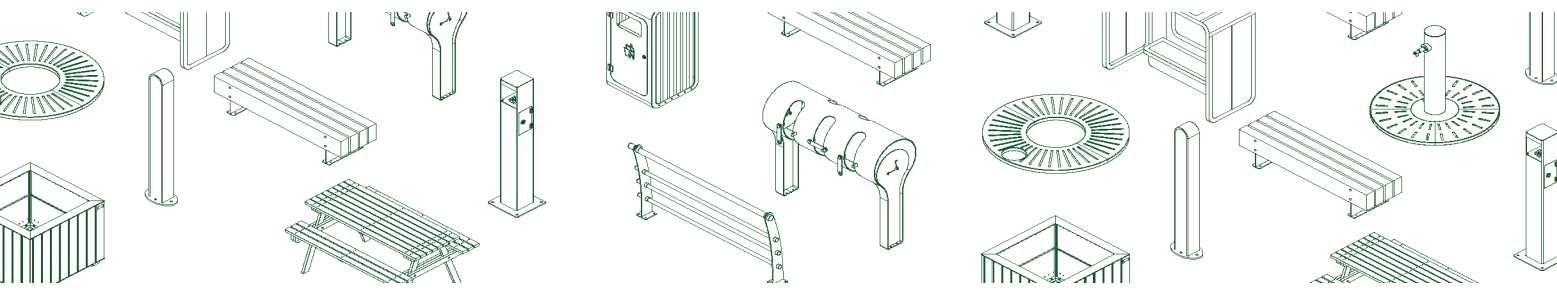

PORTUGAL
www.bragmaia.com
geral@bragmaia.com



brag
SPORT

brag
SIGN

brag
PLAY

brag
URBAN

brag
LIGHT