

+4 ANOS

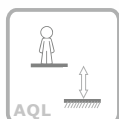

0 m

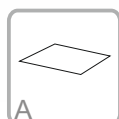

15 m²

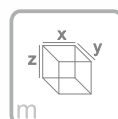

**x= 4.83
y= 0.93
z= 0.11**

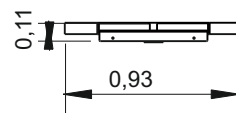
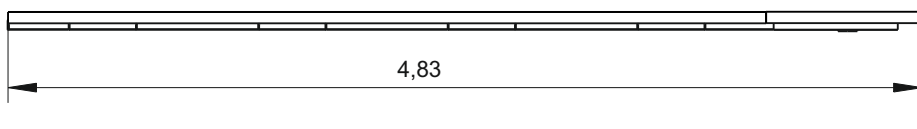

.....	A1	B1	C1
	0,00	1,30	2,04
	15	0	0
	15		

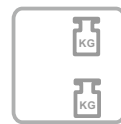
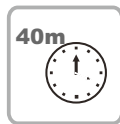
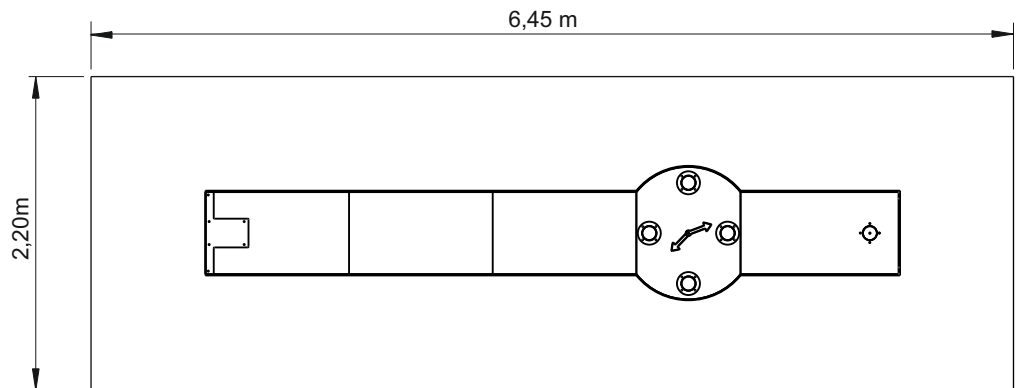

INFORMAÇÃO TÉCNICA / INFORMACIÓN TÉCNICA / TECHNICAL INFORMATION / INFORMATIONS TECHNIQUES

1 - 0.00m

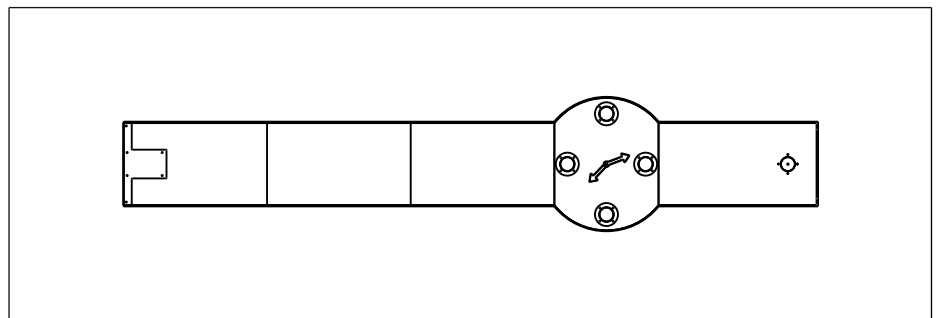



CARACTERÍSTICAS TÉCNICAS / CARACTERISTICAS TECNICAS / TECHNICAL CHARACTERISTICS / CARACTÉRISTIQUES TECHNIQUES

Estrutura e obstáculos:

Chapa de Ferro: Eletrozincada e lacada a esmalte tipo gel a 230°C, com espessura entre 50 a 70µm, de acordo com a norma UNE EN ISO 2808;

Base com relva sintética em fibra de polipropileno, 6mm de altura, cor verde, 98.500 pontos/m², densidade de 2.200 dtex e resistente aos raios U.V.

Sistema de fixação

por gravidade (em base plana e nivelada).

Opcional:

Tipo B – Sistema de fixação standard composto por base metálica aparafusada ao solo com buchas metálicas;

Parafusos e acessórios

Parafusos: Aço zincado;

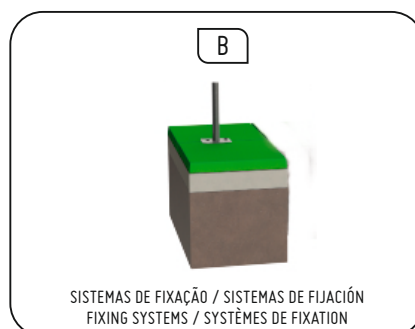

FUNÇÕES LÚDICAS/ FUNCIONES LÚDICAS / RECREATIONAL FUNCTIONS / FONCTIONS RÉCRÉATIVES



Jogar: Desenvolve a paciência, a partilha e o espírito desportivo.



CARACTERÍSTICAS TÉCNICAS / CARACTERISTICAS TECNICAS / TECHNICAL CHARACTERISTICS / CARACTÉRISTIQUES TECHNIQUES

Estructura y obstáculos:

Chapa de Hierro: Electrojincada y lacada a esmalte tipo gel a 230°C, con espesor entre 50 a 70µm, de acuerdo con la norma UNE EN ISO 2808;

Base con césped sintético en fibra de polipropileno, 6mm de altura, color verde, 98.500 puntos / m², densidad de 2.200 dtex y resistente a los rayos U.V.

Sistema de fijación

por gravedad (en base plana y nivelada).

opcional:

Tipo B – Sistema de fijación estándar compuesto por base metálica atornillada al suelo con tacos metálicos;

Tornillos y accesorios

Tornillos: Acero zincado;

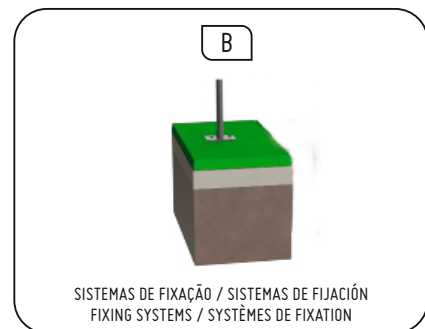

FUNÇÕES LÚDICAS/ FUNCIONES LÚDICAS / RECREATIONAL FUNCTIONS / FONCTIONS RÉCRÉATIVES



Jugar: Desarrolla la paciencia, el compartir y el espíritu deportivo.



CARACTERÍSTICAS TÉCNICAS / CARACTERISTICAS TECNICAS / TECHNICAL CHARACTERISTICS / CARACTÉRISTIQUES TECHNIQUES

Structure and obstacles:

Iron Plate: Electrocoated and lacquered with gel type enamel at 230°C, with thickness between 50 and 70µm, according to the norm UNE EN ISO 2808;

Base with synthetic polypropylene fiber grass, 6mm high, green color, 98,500 dots / m², density 2,200 dtex and resistant to U.V.

Fixation System

by gravity (on a flat and level basis).

Optional:

Type B – Standard fastening system consisting of metal base bolted to the ground with metal bushings;

Screws and accessories

Screws: Zinc plated steel;

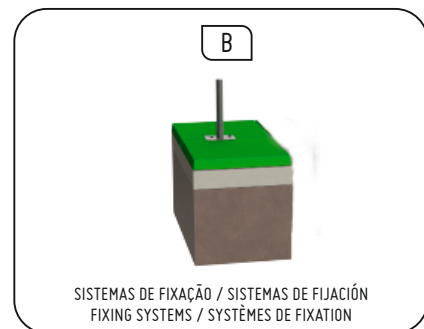

FUNÇÕES LÚDICAS/ FUNCIONES LÚDICAS / RECREATIONAL FUNCTIONS / FONCTIONS RÉCRÉATIVES



Play: Develops patience, sharing and sporting spirit.

Structure et obstacles:

Plaque de fer: Électro-plaquée et laquée avec un émail de type gel à 230°C, avec une épaisseur comprise entre 50 et 70µm, selon la norme UNE EN ISO 2808;

Base avec fibre de polypropylène synthétique, hauteur 6 mm, couleur verte, 98 500 points / m2, densité 2 200 dtex et résistance aux rayons U.V.

Système de fixation

par gravité (sur une base plate et horizontale).

Facultatif:

Type B – Système de fixation standard constitué d'une base en métal boulonnée au sol avec des bagues en métal;

Vis et accessoires

Vis: Acier zingué;

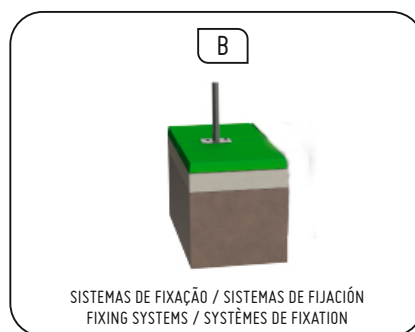

Jouer: Développe la patience, le partage et l'esprit sportif.