

TRAMPOLIM RETO

EDPR001

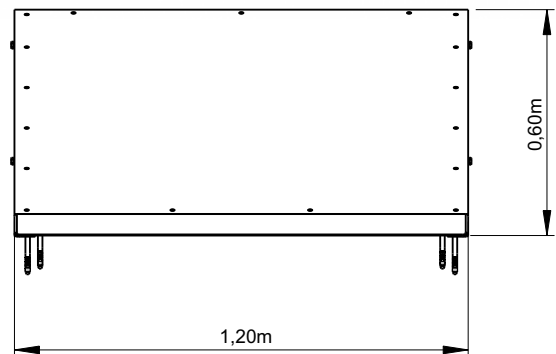

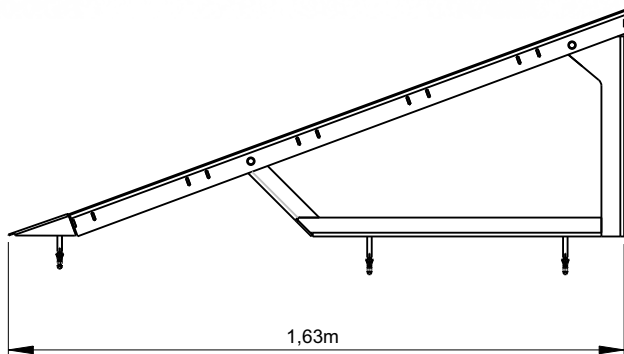
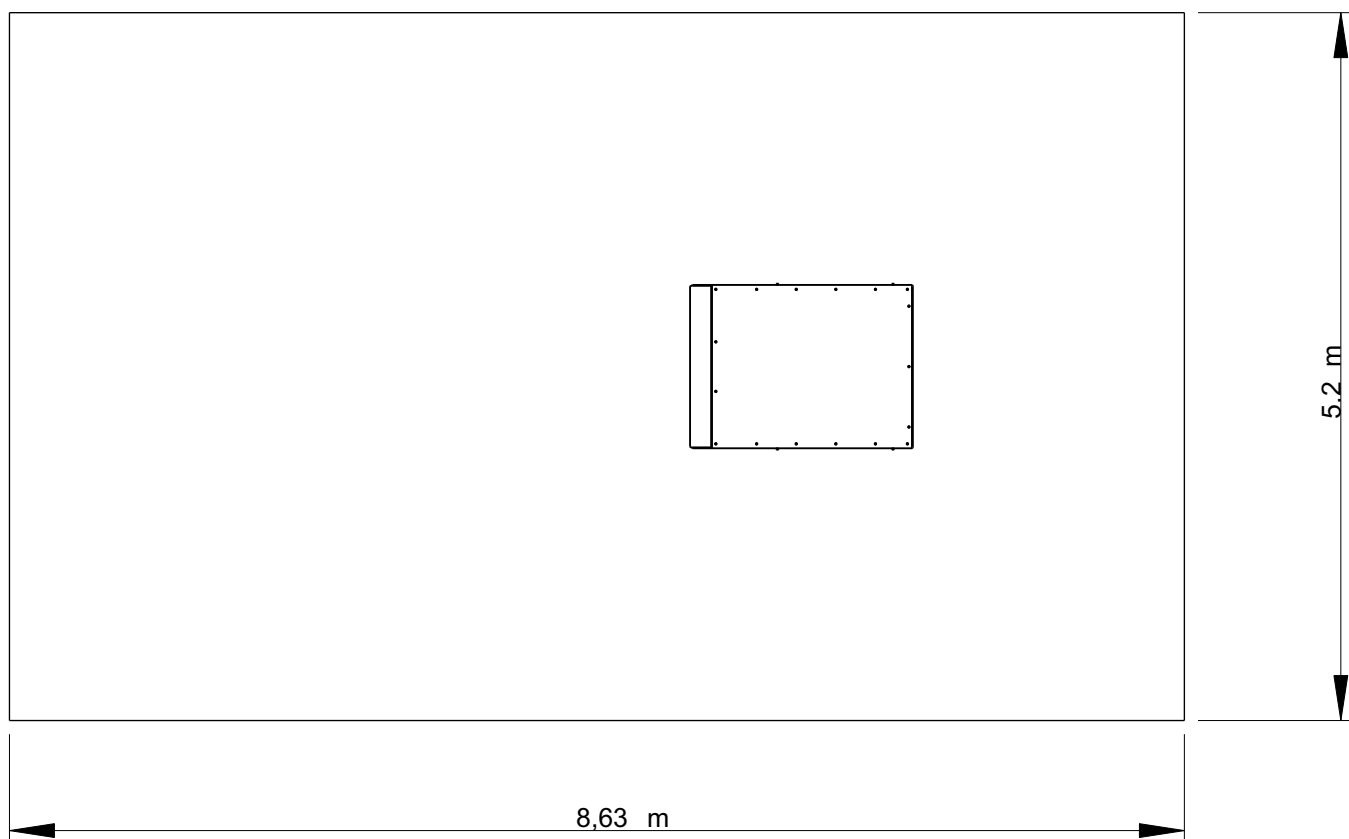

INFORMAÇÃO TÉCNICA / INFORMACIÓN TÉCNICA / TECHNICAL INFORMATION / INFORMATIONS TECHNIQUES

1 - Tranzolim Reto

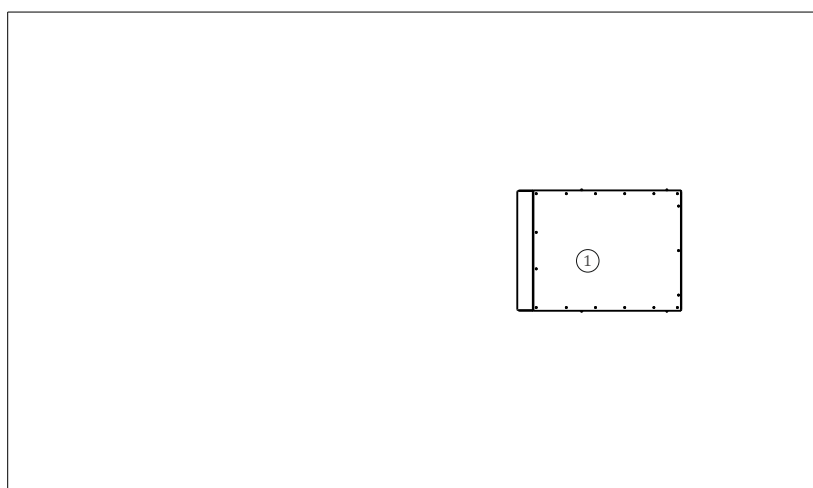



Tabuleiro

Contraplacado marítimo: antiderrapante, colado com resinas fenólicas resistentes as intempéries e raios UV, em conformidade com as normas EL 314-2/classe 3 (DIN 68 TS TCIL3: BFU 100, BS 6566 PART 8 : WBP);

Peças Metálicas

Estrutura e Vedação: Ferro com tratamento anticorrosivo de galvanização por imersão a quente de acordo com a norma EN ISO 1461;

Superfície: Chapa de ferro eletrozincada e lacada a esmalte tipo gel a 230°C, com espessura entre 50 a 70µm, de acordo com a norma UNE EN ISO 2808;

Sistema de fixação

Tipo B – Sistema de fixação standard composto por base metálica aparafusada ao solo com buchas metálicas;

Parafusos e acessórios

Parafusos: Aço zincado ou opcionalmente aço inox AISI 304;

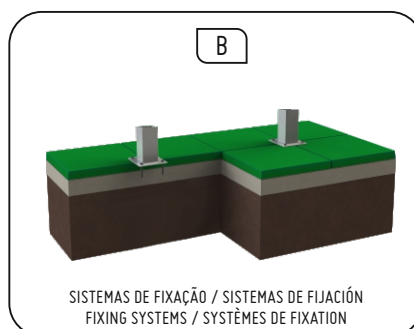



tablero

Contrachapado marítimo: antideslizante, pegado con resinas fenólicas resistentes a intemperie y rayos UV. de conformidad con las normas EL 314-2 / clase 3 (DIN 68 TS TCIL3: BFU 100, BS 6566 PART 8: WBP);

Piezas Metálicas

Estructura y Sellado: Hierro con tratamiento anticorrosivo de galvanización por inmersión en caliente de acuerdo con la norma EN ISO 1461;

Superficie: Chapa de hierro electrociclada y lacada a esmalte tipo gel a 230°C, con espesor entre 50 a 70µm, de acuerdo con la norma UNE EN ISO 2808;

Sistema de fijación

Tipo B – Sistema de fijación estándar compuesto por base metálica atornillada al suelo con tacos metálicos;

Tornillos y accesorios

Tornillos: Acero zincado o opcionalmente acero inoxidable AISI 304;

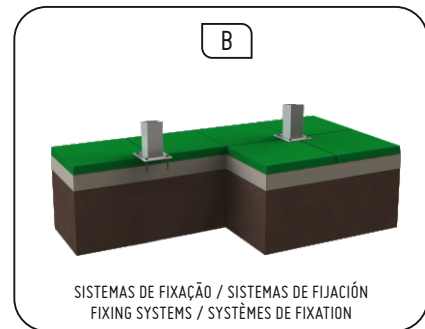



Board

Marine plywood: non-slip, bonded with phenolic resins resistant to inclement weather and UV rays. in accordance with standards EL 314-2 / class 3 (DIN 68 TS TCIL3: BFU 100, BS 6566 PART 8: WBP);

Metal parts

Structure and Seal: Iron with hot dip galvanizing anticorrosion treatment of according to EN ISO 1461;
Surface: Iron plate electrozincated and lacquered with gel-type enamel at 230°C, with thickness between 50 to 70µm, according to the standard UNE EN ISO 2808;

Fixation System

Type B – Standard fastening system consisting of metal base bolted to the ground with metal bushings;

Screws and accessories

Screws: Zinc-plated steel or optionally AISI 304 stainless steel;

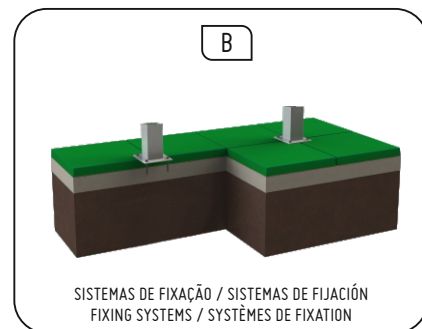

Plateaux

Contreplaqué marin: antidérapant, collé avec des résines phénoliques résistant à l'intempérie et aux rayons UV, conforme aux normes EL 314-2 / classe 3 (DIN 68 TS TCIL3: BFU 100, BS 6566 PARTIE 8: WBP);

Pièces métalliques

Structure et joint: Fer avec traitement anticorrosion par galvanisation à chaud selon EN ISO 1461; Surface: plaque de fer électrozinguée et laquée avec émail de type gel à 230°C, avec épaisseur entre 50 à 70 µm, selon la norme UNE EN ISO 2808;

Système de fixation

Type B – Système de fixation standard constitué d'une base en métal boulonnée au sol avec des bagues en métal;

Vis et accessoires

Vis: Acier zingué ou acier inoxydable AISI 304 en option;

