

POPA

ELBRC106

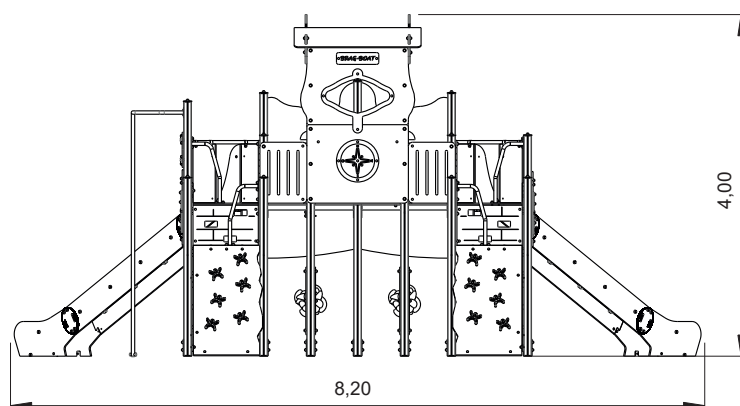

81m ²	1.80m	3-14	30

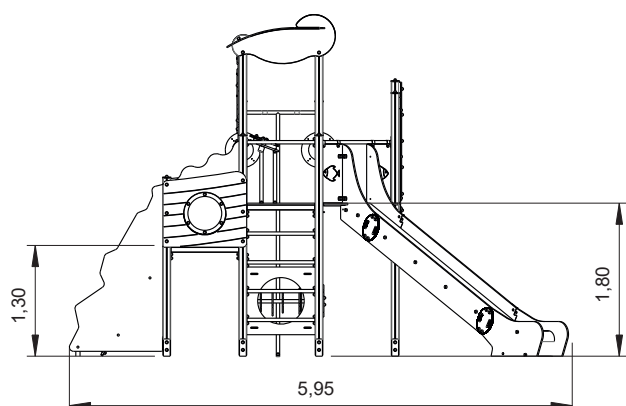

Utilização do equipamento sujeito a condições vigiadas; Zona de segurança: Área mínima requerida pela norma EN 1176-1,6
 Utilización del equipo sujeto a condiciones vigiladas; Zona de seguridad: Área mínima requerida por la norma EN 1176-1,6
 Use of equipment subject to supervised conditions; Safety zone: Minimum area required by EN 1176-1,6
 Utilisation d'équipement soumis à des conditions supervisées; Zone de sécurité: Surface minimale requise par l'EN 1176-1,6



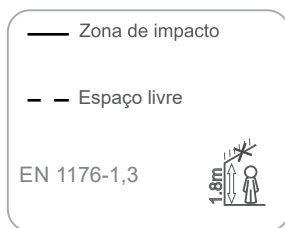

.....	①	②
	1.30	1.80
	13	68
	81	

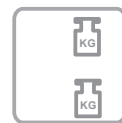
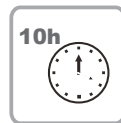
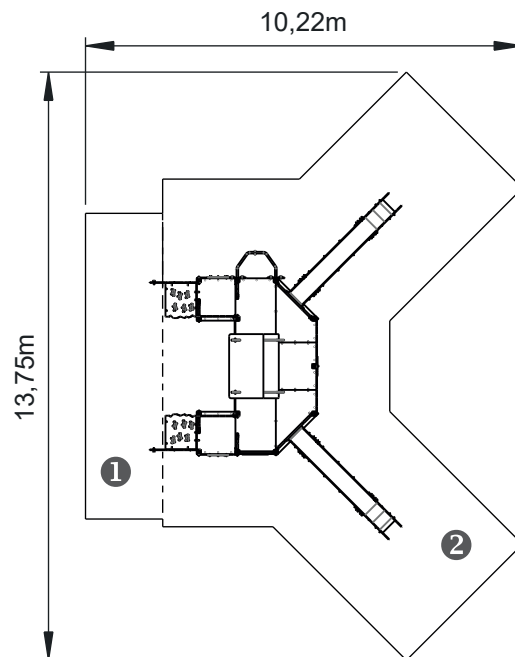

INFORMAÇÃO TÉCNICA / INFORMACIÓN TÉCNICA / TECHNICAL INFORMATION / INFORMATIONS TECHNIQUES

1 - Popa 1.80m

1.1 - Escalada 1.30m

1.2 - Escorrega 1.80m

1.3 - Varão Bombeiro 1.80m

1.4 - Cabine Comandos

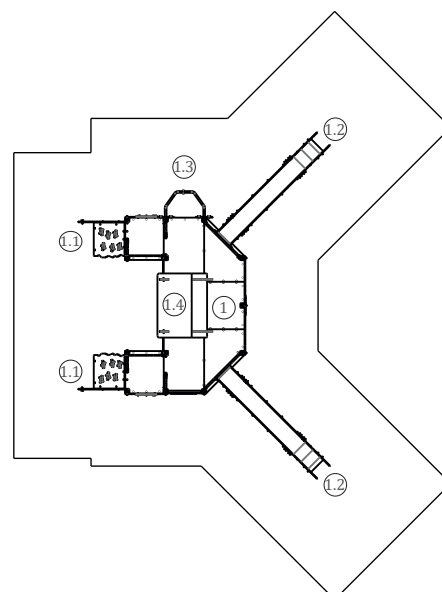



Prumos

Madeira: Pinho laminado classificado com qualidade de garantia por controlo interno contínuo. Com tratamento autoclave, protegendo-a dos ataques de cogumelos, insectos e térmitas. Acabamento final a tinta de base aquosa especialmente desenvolvida para proteger a madeira de humidades, intempéries e raios U.V.. Contém princípios activos que lhe conferem uma barreira protetora contra o aparecimento de fungos e bolores;

Painéis

HDPE: Polietileno de alta densidade monocolor ou bicolor. Por ser um polímero é caracterizado pela sua resistência a produtos químicos e à corrosão. Pela sua capacidade de elasticidade e leveza, oferece alta resistência ao impacto, sendo muito difícil quebrar. A superfície antiderrapante fornece segurança para as crianças e a sua base sintética impede o cultivo de bactérias e fungos. Não necessita de qualquer manutenção;

Contraplacado marítimo

antiderrapante, colado com resinas fenólicas resistentes as intempéries e raios UV. em conformidade com as normas EL 314-2/c classe 3 (DIN 68 TS TCIL3: BFU 100, BS 6566 PART 8 : WBP);

Peças Metálicas

Tubos:

Aço Inox: Aço Inox AISI 304 de Ø40mm;

Ferro: Com tratamento anticorrosivo de galvanização por imersão a quente de acordo com a norma EN ISO 1461;

Superfície deslizante: Chapa de Aço Inox AISI 304, dobrada e enrolada em uma só peça;

Sistema de fixação

Tipo A – Sistema de fixação standard composto por base metálica embutida no solo e chumbada com betão;

Tipo B – Sistema de fixação standard composto por base metálica aparafusada ao solo com buchas metálicas;

Tipo C – Sistema de fixação standard composto por prumo aplicado directamente no solo e chumbado com betão;

Parafusos e acessórios

Parafusos: Aço zincado ou opcionalmente aço inox AISI 304;

Cápsulas: Plástico polipropileno PP;



PROTECTORES DECORATIVOS:



Penetra profundamente na madeira destacando os veios e embelezando a madeira com os seus cores especiais transparentes



Muito resistente ao sol. Contém pigmentos microinjetados absorventes e estabilizadores dos raios U.V.



Microporoso, deixa respirar a madeira e evita as deformações naturais da madeira.

PRINCÍPIOS ACTIVOS



Fácil manutenção. Não é necessário lixar ou decapar para a aplicação de novas camadas.



Conferindo ao filme uma barreira protetora contra fungos e bolores



HIDRÓFUGO
protege contra a humidade, a chuva e impermeabiliza.

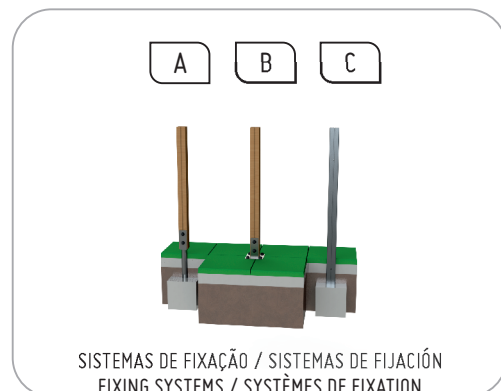



Divertir: Enquanto se divertem, as crianças adquirem imensas capacidades, desde habilidades físicas a interações sociais.



Socializar: A socialização e a imaginação são necessárias em todo o jogo. Tudo isso cria relação entre crianças e desperta o senso de convivência e a solidariedade.



Jogar: Desenvolve a paciência, a partilha e o espírito desportivo.



Trepar: Desenvolve as capacidades motrizes das crianças, o controlo do próprio corpo, o equilíbrio e a coordenação, estimulando a capacidade motora e a força nos movimentos.



Escorregar: A superfície inclinada permite que a criança deslize a grande velocidade. A sensação de velocidade fá-la sentir viva e a aprender a controlar os movimentos exercitando os reflexos e as habilidades motoras.



Postes

Madera: Pino laminado clasificado con calidad de garantía por control interno continuo. Con tratamiento autoclave, protegiéndola de los ataques de setas, insectos y termitas. Acabado final a tinta de base acuosa especialmente desarrollada para proteger la madera de humedad, intemperie y rayos U.V .. Contiene principios activos que le confieren una barrera protectora contra la aparición de hongos y mohos;

paneles

HDPE: Polietileno de alta densidad monocolor o bicolor. Por ser un polímero es caracterizado por su resistencia a los productos químicos ya la corrosión. Por su capacidad de elasticidad y ligereza, ofrece alta resistencia al impacto, siendo muy difícil romper. La superficie antideslizante proporciona seguridad para los niños y su base sintética impide el cultivo de bacterias y hongos. No necesita mantenimiento;

Contrachapado marítimo

antiderrapante, pegado con resinas fenólicas resistentes a la intemperie y los rayos UV. de conformidad con las normas EL 314-2 / clase 3 (DIN 68 TS TCIL3: BFU 100, BS 6566 PART 8: WBP);

Piezas Metálicas

tuberías:

Acero Inox: Acero Inox AISI 304 de Ø40mm;

Hierro: Con tratamiento anticorrosivo de galvanización por inmersión en caliente de acuerdo con la norma EN ISO 1461;

Superficie deslizante: Chapa de acero inoxidable AISI 304, doblada y enrollada en una sola pieza;

Sistema de fijación

Tipo A – Sistema de fijación estándar compuesto por base metálica embutida en el suelo y plomada con hormigón;

Tipo B – Sistema de fijación estándar compuesto por base metálica atornillada al suelo con tacos metálicos;

Tipo C – Sistema de fijación estándar compuesto por pluma aplicada directamente en el suelo y plomado con hormigón;

Tornillos y accesorios

Tornillos: Acero zincado o opcionalmente acero inoxidable AISI 304;

Cápsulas: Plástico polipropileno PP;



PROTECTORES DECORATIVOS:



Penetra profundamente en la madera destacando los vetas y embellece la madera con los sus colores especiales transparentes



Fácil mantenimiento. No es necesario lijar o decapar para la aplicación de nuevas capas.



Muy resistente al sol, contiene pigmentos micronizados absorbentes y estabilizadores de los rayos U.V.



PRINCIPIOS ACTIVOS que le da a la película una barrera protectora contra los hongos y los mohos



Microporosos, deja respirar la madera y evita las deformaciones naturales de la madera.



HIDRÓFUGO protege contra la humedad, la lluvia e impermeabiliza.

A B C

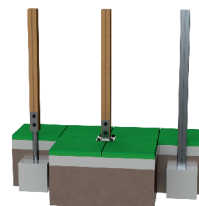

SISTEMAS DE FIXAÇÃO / SISTEMAS DE FIJACIÓN
FIXING SYSTEMS / SYSTÈMES DE FIXATION



Divertir: Mientras se divierten, los niños adquieren inmensas capacidades, desde habilidades físicas a interacciones sociales.



Socializar: La socialización y la imaginación son necesarias en todo el juego. Todo esto crea relación entre niños y despierta el sentido de convivencia y la solidaridad.



Jugar: Desarrolla la paciencia, el compartir y el espíritu deportivo.



Trepar: Desarrolla las capacidades motrices de los niños, el control del propio cuerpo, el equilibrio y la coordinación, estimulando la capacidad motora y la fuerza en los movimientos.



Escurrir: La superficie inclinada permite que el niño deslice a gran velocidad. La sensación de velocidad la hace sentir viva y aprender a controlar los movimientos ejercitando los reflejos y las habilidades motoras.



Plums

Wood: Laminated pine classified with guarantee quality by continuous internal control. With autoclave treatment, protecting it from attacks of mushrooms, insects and termites. Water-based paint finish specially developed to protect wood from moisture, weather and U.V. rays. Contains active principles that give it a protective barrier against the appearance of fungi and molds;

Panels

HDPE: High density polyethylene mono or two color. Because it is a polymer it is characterized by its resistance to chemicals and corrosion. Due to its elasticity and lightness, it offers high impact resistance and is very difficult to break. The non-slip surface provides safety for children and its synthetic base prevents the growth of bacteria and fungi. It does not require any maintenance;

Marine Plywood

anti-slip, bonded with weather resistant phenol resins and UV rays. in accordance with standards EL 314-2 / class 3 (DIN 68 TS TCIL3: BFU 100, BS 6566 PART 8: WBP);

Metal parts

Tubes:

Stainless Steel: Stainless Steel AISI 304 Ø40mm;

Iron: With anticorrosive treatment of hot dip galvanizing according to EN ISO 1461;

Sliding surface: AISI 304 stainless steel plate, folded and rolled in one piece;

Fixation System

Type A – Standard fixing system composed of metal base embedded in the ground and cast with concrete;

Type B – Standard fastening system consisting of metal base bolted to the ground with metal bushings;

Type C – Standard fixing system composed of plumbing applied directly to the ground and cast with concrete;







Screws and accessories

Screws: Zinc-plated steel or optionally AISI 304 stainless steel;

Capsules: PP polypropylene plastic;



DECORATIVE PROTECTORS:

 <p>Penetrates deep into wood highlighting and embellishing the wood with their special transparent colors</p>	 <p>Very resistant to sun. Contains absorbent micronized pigments and UV stabilizers.</p>	 <p>Microporous, let the wood breathe and prevents the natural deformations of the wood.</p>
 <p>Easy maintenance. No sanding or pickling is required for the application of new layers.</p>	 <p>Giving the film a protective barrier against fungi and molds</p>	 <p>WATER-REPELLENT protects against moisture, rain and waterproof.</p>

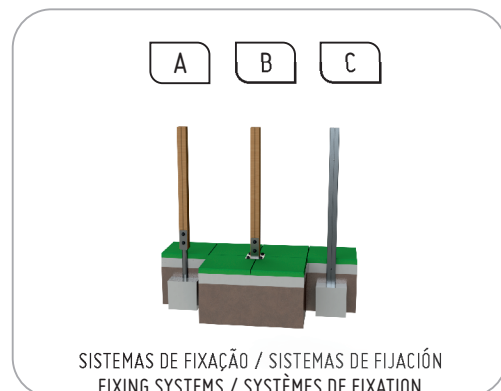



Fun: While having fun, children acquire immense abilities, from physical abilities to social interactions.



Socializing: Socialization and imagination are necessary throughout the game. All this creates a relationship between children and awakens the sense of coexistence and solidarity.



Play: Develops patience, sharing and sporting spirit.



Climb: It develops children's motor skills, body control, balance and coordination, stimulating motor ability and strength in movements.



Sliding: The sloping surface allows the child to slide at high speed. The sensation of speed makes you feel alive and learn to control your movements by exercising reflexes and motor skills.



Poteaux

Bois: Pin stratifié classé avec une qualité garantie par contrôle interne continu. Avec traitement autoclave, le protégeant des attaques de champignons, d'insectes et de termites. Finition de peinture à base d'eau spécialement développée pour protéger le bois contre l'humidité, les intempéries et les rayons UV. Contient des principes actifs qui lui confèrent une barrière protectrice contre l'apparition de champignons et de moisissures;

Panneaux

HDPE: Polyéthylène haute densité mono ou bicolore. Parce que c'est un polymère c'est caractérisé par sa résistance aux produits chimiques et à la corrosion. Grâce à son élasticité et à sa légèreté, il offre une grande résistance aux chocs et est très difficile à briser. La surface antidérapante assure la sécurité des enfants et sa base synthétique empêche la croissance des bactéries et des champignons. Il ne nécessite aucun entretien

Contreplaqué Marine

anti-dérapant, collé avec des résines phénoliques résistantes aux intempéries et aux rayons UV. conforme aux normes EL 314-2 / classe 3 (DIN 68 TS TCIL3: BFU 100, BS 6566 PARTIE 8: WBP);

Pièces métalliques

Tubes:

Acier inoxydable: acier inoxydable AISI 304 Ø40mm;

Fer: avec traitement anticorrosion de la galvanisation à chaud selon la norme EN ISO 1461;

Surface coulissante: plaque en acier inoxydable AISI 304, pliée et roulée en une seule pièce;

Système de fixation

Type A - Système de fixation standard composé d'une base en métal noyée dans le sol et coulée avec du béton;

Type B - Système de fixation standard constitué d'une base en métal boulonnée au sol avec des bagues en métal;

Type C - Système de fixation standard composé de plomberie appliquée directement sur le sol et coulée avec du béton;

Vis et accessoires

Vis: Acier zingué ou acier inoxydable AISI 304 en option;

Capsules: PP polypropylène plastique;



PROTECTEURS DÉCORATIFS:



Pénètre profondément dans le bois en soulignant les veines et en embellissant le bois avec ses couleurs transparentes spéciales



Facile d'entretien. Aucun ponçage ou décapage n'est requis pour l'application de nouvelles couches.



Très résistant au soleil il contient des pigments microscopiques d'absorption des rayonnements UV.



PRINCIPES ACTIFS
Donnant au film une barrière protectrice contre les champignons et les moisissures



Microporeux, laisse respirer le bois et empêche les déformations naturelles du bois.



HYDROFUGE
protège contre l'humidité, la pluie et imperméable.

A B C

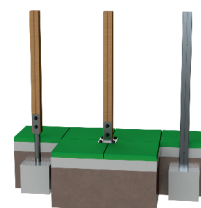

SISTEMAS DE FIXAÇÃO / SISTEMAS DE FIJACIÓN
FIXING SYSTEMS / SYSTÈMES DE FIXATION



Amusement: tout en s'amusant, les enfants acquièrent d'énormes capacités, allant des capacités physiques aux interactions sociales.



Socialiser: la socialisation et l'imagination sont nécessaires tout au long du jeu. Tout cela crée une relation entre les enfants et éveille le sentiment de coexistence et de solidarité.



Jouer: Développe la patience, le partage et l'esprit sportif.



Escalade: Il développe les capacités motrices, le contrôle du corps, l'équilibre et la coordination des enfants, stimulant la capacité motrice et la force dans les mouvements.



Coulissante: la surface inclinée permet à l'enfant de glisser à grande vitesse. La sensation de vitesse vous permet de vous sentir vivant et d'apprendre à contrôler vos mouvements en exerçant des réflexes et des habiletés motrices.