

Tolerância Geral: ± 5%



18,00 m²



1,00 m



0.5-3



1



PORTUGAL
www.bragmaia.com
geral@bragmaia.com

brag
PLAY

brag
URBAN

brag
SPORT

brag
SIGN

brag
LIGHT

MEDIDAS GERAIS / MEDIDAS GENERALES / GENERAL MEASURES / MESURES GÉNÉRALES

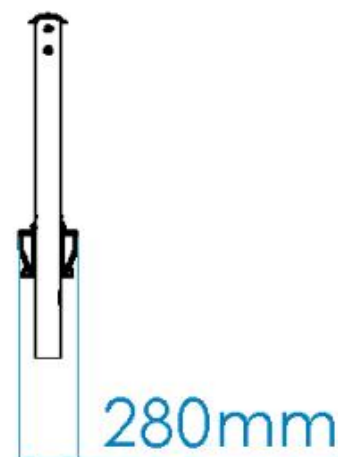
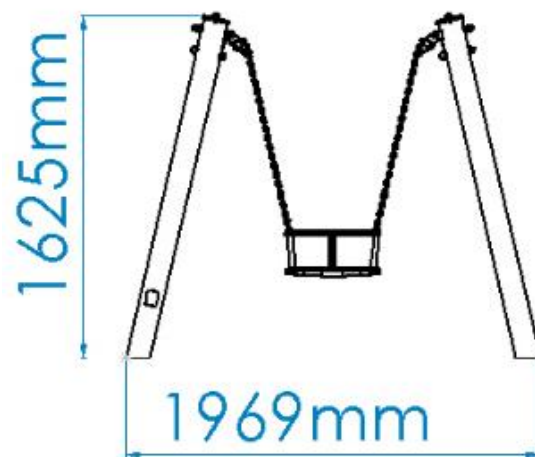

INSTALAÇÃO / INSTALACIÓN / INSTALLATION / INSTALLATION



0,20m³



01:30h



2x



19,00kg



58,00kg



1

18,00m²



1,00m

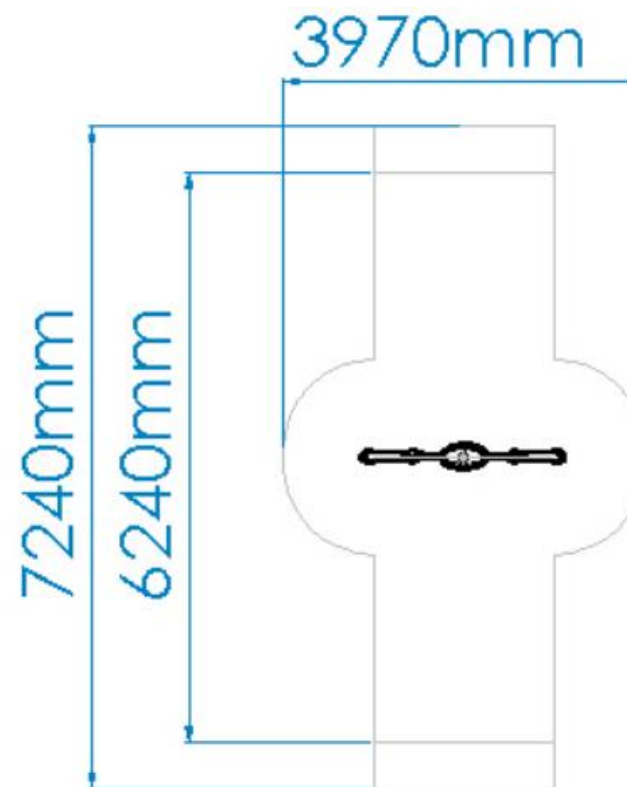



DESCRIÇÃO

Equipamento BragPLAY, Baloço Psyche 1 (AQL – 1m) composto por 2 prumos Inclinados em Inox Ø114 e 1 assento bebe em borracha termoplástica com correntes galvanizadas Ø5mm. Ferragens em aço inox A2. Fixação ao solo tipo Y (chumbar)

Medidas gerais (CxLxA): 1969x280x1625mm
Área de segurança: 18m² | Área livre: 7240x3970mm
Faixa etária: 0.5-3anos
Nº de utilizadores: 1

CARACTERÍSTICAS TÉCNICAS

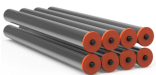

PRUMO AÇO INOX

Tubo de perfil redondo de Ø114x3mm, em aço inoxidável AISI 304, de acordo com a norma ISO 1127, DIN 17455/17457, com acabamento 2B. Tacos em BragPO aparafusados ao perfil.
Garantia: 15 anos

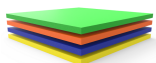

BRAGPO

BragPO HDPE de alta densidade monocolor ou bicolor, livre de HPA. Caracterizado pela sua extrema leveza e elasticidade, resistência a produtos químicos, corrosão, raios UV (UNE EN ISO 4892), alta resistência à inflamabilidade (UNE-EN ISO 11925-2) e resistência a impactos (ISO 527-1). Não necessita de qualquer manutenção.
Garantia: 15 anos



CADEIRA BEBÉ

Em borracha termoplástica, com reforço interior em alumínio. Correntes com Ø5mm em aço galvanizado a quente.



FERRAGENS EM AÇO INOX

Ferragens em aço inox, de acordo com a norma NF EN 10088, protegidas por cápsulas em polipropileno PP.



PEÇA ARTICULADA PARA BALOIÇOS

Ferragem com 2 rotações com perno M16 em aço inox AISI304. Normativa de produção e montagem EN1176-7.





SISTEMA DE FIXAÇÃO

Tipo Y - Sistema de fixação composto por base metálica embutida ou por prumos aplicado diretamente no solo e chumbada com betão.

A base metálica embutida é fabricada em chapa de aço carbono, com tratamento anticorrosivo de galvanização por imersão a quente com espessura entre 120 a 140µm de acordo com a norma EN ISO 1461, que permite a sua colocação sem que o prumo entre em contacto direto com o solo. A sua fixação ao prumo é feita por um sistema de aperto rápido aumentando a longevidade do prumo e a sua fácil e rápida substituição em caso de necessidade.

FUNÇÕES LÚDICAS



DIVERSÃO

Enquanto se divertem, as crianças desenvolvem imensas capacidades, tais como: habilidades físicas, emocionais, sociais e motoras.



SOCIALIZAR

A importância de brincar reside no facto das brincadeiras promoverem a interação social, despertando-lhes o senso de convivência e solidariedade. Enquanto brincam, as crianças aprendem a partilhar, respeitar e ouvir os outros, desta forma iniciam a sua preparação para viver em sociedade.



BALOIÇAR

Esta ação ajuda a desenvolver o equilíbrio da criança e ensina-lhe como controlar os movimentos com o balanço e vigor correto, o que melhora a atividade psicomotora e coordenação do corpo. O ato de baloiçar é essencialmente importante para crianças com défice ao nível de percepção visual, uma vez que ajuda o cérebro a processar a velocidade e o sentido do movimento.



ESTIMULAÇÃO VISUAL

É através da estimulação visual, que as crianças adquirem estímulos essenciais que vão impulsionar o desenvolvimento do seu campo visual. Assim, é essencial que estas desenvolvam uma visão funcional, que as permita brincar, socializar para interiorizar informações do meio que as rodeia e desenvolver competências.



ESTIMULAÇÃO TÁTIL

É através do ato de brincar que se consegue estimular o sistema tátil de uma forma fácil e simples, a introdução de objetos com diferentes texturas permite que as crianças comecem a utilizar as mãos e desta forma, despertar a sua percepção sensorial tátil.



CRIATIVIDADE

São ações como inventar, sonhar, pensar e experimentar, que desenvolvem a criatividade das crianças. Dessa forma, estas passam a compreender e a usar as suas competências orais, motoras e cognitivas nas mais diversas atividades.



DESENVOLVIMENTO COGNITIVO

Um aspeto importante do ato de brincar, é o desenvolvimento do raciocínio, da sua imaginação e atenção. Novas brincadeiras são essenciais para estimular a capacidade de pensar, compreender e agir, desenvolvendo o sistema cognitivo.



NORMAS



EN 1176-1
Equipamentos e superfícies para espaços de jogo e recreio
Parte 1: Requisitos de segurança e métodos de ensaio gerais



EN 1176-2
Equipamentos e superfícies para espaços de jogo e recreio
Parte 2: Requisitos de segurança e métodos de ensaio adicionais, específicos para baloiços

CONFIDENCIALIDADE E PROPRIEDADE INTELECTUAL

A informação contida neste documento é confidencial, não podendo o destinatário do mesmo reproduzi-la ou permitir a terceiros que a obtenham, utilizem ou divulguem sem a prévia e expressa autorização da BRAGMAIA. Todos os direitos de propriedade intelectual sobre os desenhos e modelos apresentados são da titularidade exclusiva da BRAGMAIA, sendo expressamente proibida a prática de qualquer ato de exploração dos mesmos sem o consentimento desta, nos termos do código da propriedade industrial e do código do direito de autor e dos direitos conexos. A violação da obrigação de confidencialidade e/ou dos direitos de propriedade intelectual da BRAGMAIA, pode dar origem a responsabilidade civil e criminal.





DESCRIPCIÓN

Equipamiento BragPLAY, Columpio "PSYCHE 1" (HIC – 1m). Compuesto por 2 postes Inclinaados de acero Inox Ø114 y 1 asiento bebé de goma termoplástica y cadenas galvanizadas de Ø5mm. Herrajes de acero Inox A2. Fijación al suelo Tipo Y (hormigonado)

Medidas generales (LxAnxA): 1969x280x1625mm
Área de seguridad: 18m² | Área libre: 7240x3970mm
Rango de edad: 0.5-3 años
Nº de usuarios: 1 niño

CARACTERÍSTICAS TÉCNICAS

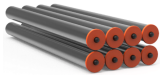

POSTE ACERO INOX

Poste perfilado redondo ø114x3mm, en acero inoxidable AISI 304, según ISO 1127, DIN 17455/17457, acabado con 2B. Tapas en BragPO atornilladas al perfil.
Garantía: 15 años

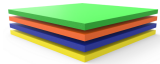

BRAGPO

BragPO HDPE de alta densidad monocolor o bicolor, sin HPA. Caracterizado por su extrema ligereza y elasticidad, resistencia a productos químicos, corrosión, rayos UV (UNE EN ISO 4892), a la inflamabilidad (UNE-EN ISO 11925-2) y al impacto (ISO 527-1). No necesita ningún tipo de mantenimiento.
Garantía: 15 años



SILLA BEBÉ

En caucho termoplástico con refuerzo interior de aluminio. Cadenas de Ø5mm en acero galvanizado en caliente.



HERRAJES EN ACERO INOX

Herrajes en acero inox, según NF EN 10088, protegidos por cápsulas en polipropileno PP.



PIEZA ARTICULADA PARA COLUMPIOS

Herrajes con 2 rotaciones con perno M16 en acero inoxidable AISI304. Normativa de producción y montaje EN1176-7.





SISTEMA DE FIJACIÓN

Tipo Y - Sistema de fijación estándar compuesto por una base metálica o poste embutido al suelo y con relleno de hormigón.

La base metálica incorporada está fabricada en chapa de acero de carbono, con tratamiento anticorrosivo por inmersión en caliente de 120 a 140µm de espesor según EN ISO 1461, que permite su colocación sin que el poste entre en contacto directo con el suelo. Su fijación a al poste se realiza por un sistema de sujeción rápido aumentando la longevidad del poste y su fácil y rápida sustitución en caso de necesidad.

FUNCIONES DE JUEGO



DIVERSIÓN

Mientras se divierten, los niños desarrollan una gran diversidad de capacidades, tales como: habilidades físicas, emocionales, sociales y motrices.



SOCIALIZAR

La importancia del juego reside en que éste, promueve la interacción social, despertando en los niños la necesidad de convivencia y solidaridad. Mientras juegan, los niños aprenden a compartir, respetar y escuchar a los demás niños. Es la mejor forma de iniciar su preparación para convivir en sociedad.



COLUMPIARSE

Esta acción le ayuda a desarrollar el equilibrio, enseñándole cómo controlar los movimientos a través del balanceo, así como a utilizar la energía necesaria correcta, lo que mejora la actividad psicomotora y coordinación del propio cuerpo. El efecto del balanceo es esencialmente importante para niños con cierto déficit a nivel de percepción visual, ya que ayuda a su cerebro a procesar la velocidad y el concepto del movimiento.



ESTIMULACIÓN VISUAL

A través de la estimulación visual, los niños adquieren incentivos esenciales que van a aumentar el desarrollo de su campo visual. De esta manera, es primordial que ellos desarrollen una visión funcional que les permita jugar y socializar para interiorizar informaciones del medio que los rodea, así como a desarrollar capacidades.



ESTIMULACIÓN TÁCTIL

A través del acto del juego se consigue estimular el sentido táctil de una forma fácil y simple. La introducción de objetos con diferentes texturas permite que los niños comiencen a utilizar las manos, y de esta forma, se despierte su percepción sensorial táctil.



CREATIVIDAD

Se trata de acciones tales como inventar, soñar, pensar y percibir, que desarrollan la creatividad de los niños. De esta manera pasan a comprender y a usar sus competencias orales, motoras y cognitivas en las más diversas actividades.



DESARROLLO COGNITIVO

Un aspecto importante del simple acto de jugar es el desarrollo del raciocinio, de su imaginación y atención. Son esenciales nuevas diversiones, a través del juego, para estimular la capacidad de pensar, comprender y reaccionar, desarrollando así, el sistema cognitivo.



NORMAS



EN 1176-1
Equipamiento de las áreas de juego y superficies
Parte 1: Requisitos generales de seguridad y métodos de ensayo.



EN 1176-2
Equipamiento de las áreas de juego y superficies
Parte 2: Requisitos de seguridad y métodos de ensayo adicionales específicos para columpios

CONFIDENCIALIDAD Y PROPIEDAD INTELECTUAL

La información contenida en este documento es estrictamente confidencial, no pudiendo el destinatario reproducirla o permitir a terceros que la adquieran, utilicen o divulguen sin la previa y expresa autorización de BRAGMAIA. Todos los derechos de propiedad intelectual sobre los diseños y modelos presentados son de titularidad exclusiva de BRAGMAIA, estando expresamente prohibida la práctica de cualquier acto de usurpación de los mismos sin el previo consentimiento de la empresa, dentro de los términos del código de propiedad industrial y del código de derechos de autor y derechos análogos. La violación de la obligación de confidencialidad y/o de los derechos de propiedad intelectual de BRAGMAIA, puede dar origen a responsabilidad civil y criminal.





DESCRIPTION

BragPLAY equipment, Swing Psyche 1 (FFH-1m) composed of 2 inclined posts in stainless of Ø114 and 1 baby seat in a thermoplastic rubber with galvanized chains Ø5mm. Hardware in stainless steel A2. Ground fixation type Y (in-ground).

General measures (LxWxH): 1969x280x1625mm
Safety area: 18m² | Free area: 7240x3970mm
Age range: 0,5-3 years old
Number of users: 1

TECHNICAL FEATURES

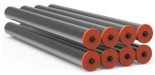

STAINLESS STEEL BEAM

Ø114x3mm round profile tube, in AISI 304 stainless steel, according to ISO 1127, DIN 17455/17457, with 2B finish. BragPO cover fixed to the profile.
Guarantee :15 years.

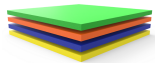

BRAGPO

BragPO HDPE of high density in one color or bicolor, free of HPA. Characterized by its extreme lightness and elasticity, resistance to chemicals, corrosion, UV rays (UNE EN ISO 4892), to flammability (UNE-EN ISO 11925-2) and impact (ISO 527-1). It doesn't need any maintenance.
Guarantee: 15 years.



BABY CHAIR

In thermoplastic rubber, with aluminum inner reinforcement. Chains with Ø5mm in hot-dip galvanized steel.



STAINLESS STEEL HARDWARE

Stainless steel, in accordance with NF EN 10088, protected by polypropylene PP capsules.



SWING PIECE

Hardware with 2 rotations with M16 pin in stainless steel AISI304. Production standards and mounting EN1176-7.





FIXATION SYSTEM

Type Y - Fixation system composed of built-in metal base or plumbing applied directly to the ground and concrete sinker.

The built-in metal base is made of carbon steel sheet, with corrosion-resistant hot-dip galvanisation treatment of between 120 and 140µm thickness according to EN ISO 1461, which allows its placement without the plumb in direct contact with the ground. Its attachment to the plumb line is made by a quick clamping system increasing the longevity of the plumb line and its easy and fast replacement in case of need.

PLAY FUNCTIONS



FUN

While having fun, children acquire immense abilities, from physical abilities to social interactions.



SOCIALIZING

Socialization and imagination are necessary throughout the game. All this creates a relationship between children and awakens the sense of coexistence and solidarity.



SWING

This action helps to develop the child's balance and teaches him how to control the movements with the correct balance and vigor, which improves the psychomotor activity and body coordination. Swinging is essentially important for children with a visual perception deficit, as it helps the brain process the speed and direction of movement.



VISUAL STIMULATION

It's through visual stimulation that children acquire essential stimuli that will boost the development of their visual field. Thus, it's essential that they develop a functional vision that allows them to play, socialize to internalize information from their surroundings and develop skills.



TACTILE STIMULATION

It's through the act of play that it's possible to stimulate the tactile system in an easy and simple way, the introduction of objects with different textures allows children to start using their hands and thus awaken their tactile sensory perception.



CREATIVITY

These are actions such as inventing, dreaming, thinking and experimenting, which develop children's creativity. In this way, they begin to understand and use their oral, motor and cognitive skills in the most diverse activities.



COGNITIVE DEVELOPMENT

An important aspect of play is the development of reasoning, imagination and attention. New games are essential to stimulate the ability to think, understand and act, developing the cognitive system.



STANDARTS



EN 1176-1
Playground equipment and surfacing
Part 1: General safety requirements and test methods



EN 1176-2
Playground equipment and surfacing
Part 2: Additional specific safety requirements and test methods for swings

CONFIDENTIALITY AND INTELLECTUAL PROPERTY

The information contained in this document is confidential, and the recipient cannot reproduce it or allow third parties to obtain, use or disclose it without the prior and express authorization of BRAGMAIA.
All intellectual property rights over the designs and models presented are the exclusive property of BRAGMAIA, and the practice of any act of exploitation thereof without the consent of the latter, under the terms of the industrial property code and the copyright code and related rights. Violation of BRAGMAIA's obligation of confidentiality and / or intellectual property rights may give rise to civil and criminal liability.





DESCRIPTION

Équipement BragPLAY, balançoire Psyche 1 (NQA - 1m) composée de 2 états inclinés en acier inoxydable Ø114 et 1 siège bébé en caoutchouc thermoplastique avec chaînes galvanisées Ø5mm. Quincaillerie en acier inoxydable A2. Fixation au sol type Y (plomb).

Dimensions globales (Lxlxh): 1969x280x1625mm
Zone de sécurité: 18m² | Zone libre: 7240x3970mm
Tranche d'âge: 0.5-3 ans
Nombre d'utilisateurs: 1

CARACTÉRISTIQUES TECHNIQUES

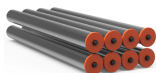

POUTRE ACIER INOX

Tube profilé rond ø114x3mm, en acier inoxydable AISI 304, selon les normes ISSO 1127, DIN 17455/17457, à finition 2B. Embout en BragPO fixés sur le profil.
Garantie: 15 ans.

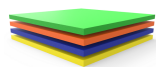

BRAGPO

BragPO HDPE d'une couleur ou bicolore de haute densité, sans HPA. Caractérisé par son extrême légèreté et élasticité, résistante aux produits chimiques, à la corrosion, aux rayons UV (UNE EN ISO 4892), à l'inflammabilité (UNE-EN ISO 11925-2) et aux impacts (ISO 527-1). Pas d'entretien nécessaire.
Garantie: 15 ans.



BALANÇOIRE À GODET

En caoutchouc thermoplastique, avec renfort intérieur en aluminium. Chaînes de Ø5mm en acier galvanisé à chaud.



FERRURES EN ACIER INOXYDABLE

Ferrures en acier inoxydable, selon la norme NF EN 10088, protégé par des capsules en polypropylène PP.



PIÈCE ARTICULÉE POUR BALANÇOIRES

Matériel avec 2 rotations avec broche M16 en acier inoxydable AISI304. Norme de production et de montage EN1176-7.





SISTÈME DE FIXATION

Type Y - Système de fixation composé d'une base métallique encastrée ou d'une poutre appliquée directement au sol et bétonnée.

La base métallique encastrée est fabriquée en tôle d'acier carbone, avec un traitement anticorrosion par galvanisation par immersion à chaud d'une épaisseur comprise entre 120 et 140µm selon la norme EN ISO 1461, qui permet sa pose sans que la poutre rentre en contact direct avec le sol. Sa fixation à la poutre est réalisée par un système de serrage rapide augmentant sa longévité et facilitant son remplacement, qui sera rapide en cas de besoin.

FONCTIONS DE JEU



AMUSEMENT

En s'amusant, les enfants développent plusieurs capacités telles que des habilités physiques, émotionnelles, sociales et motrices.



SOCIALES

L'importance de jouer se note dans l'interaction sociale que nécessitent ces activités, réveillant en eux le sens de la convivialité et de la solidarité. En jouant, les enfants apprennent à partager, respecter, et écouter autrui. De cette manière, ils débutent leur apprentissage en vie de société.



SE BALANCER

Cette action aide l'enfant à développer son équilibre et lui apprend comment contrôler ses mouvements avant/arrière afin de trouver la bonne propulsion, ce qui améliore ses aptitudes psychomotrices et coordinatrices du corps. Se balancer est spécialement important pour les enfants avec une déficience au niveau de la perception visuelle, en effet cette action aide le cerveau à assimiler la vitesse et le sens des mouvements.



STIMULATION VISUELLE

C'est au travers de cette action que les enfants vont comprendre le fonctionnement de plusieurs activités, c'est pour cela qu'il est important qu'ils développent leur perception visuelle et leur champ de vision. Grâce à ses capacités, ils pourront assimiler plus facilement des informations qui les entourent et développer plus facilement certaines capacités.



STIMULATION TACTILE

Certains jeux sont tactiles. En effet, en faisant appel à différentes formes et matières pour lesquelles l'enfant utilise ses mains afin de trouver une solution.



CRÉATIVITÉ

Rêver, inventer, penser et essayer, se sont là des actes qui aident les enfants à développer leur créativité. De cette manière, ces derniers comprennent comment utiliser leur compétence orale, motrice et cognitive dans de diverses situations.



DÉVELOPPEMENT COGNITIF

Un aspect important lors de la diversion des enfants, c'est le développement de leurs sens, imagination et attention. De nouveaux jeux sont essentiels pour stimuler leurs capacités à penser, comprendre et agir.



NORMES



EN 1176-1
Équipements et sols d'aires de jeux
Partie 1: Exigences de sécurité et méthodes d'essai générales



EN 1176-2
Équipement et sols d'aires de jeux
Partie 2: Exigences de sécurité et méthodes d'essai complémentaires spécifiques aux balançoires

CONFIDENTIALITÉ ET PROPRIÉTÉ INTELLECTUELLE

Les informations contenues dans ce document sont confidentielles et le destinataire ne peut pas les reproduire ni permettre à des tiers de les obtenir, de les utiliser ou de les divulguer sans l'autorisation préalable et expresse de BRAGMAIA.
Tous les droits de propriété intellectuelle sur les dessins et modèles présentés sont propriété exclusive de BRAGMAIA, et la pratique d'un acte d'exploitation de ceux-ci sans le consentement de cette dernière, selon les termes du code de la propriété industrielle et du code du droit d'auteur et des droits voisins. La violation de l'obligation de confidentialité et / ou des droits de propriété intellectuelle de BRAGMAIA peut engager à la responsabilité civile et pénale.

