





SOFT 1

ELDAN085AL



| | | | |
|---|---|---|--|
|  |  |  |  |
| 54m ² | 1.30m | 3-14 | 6 |

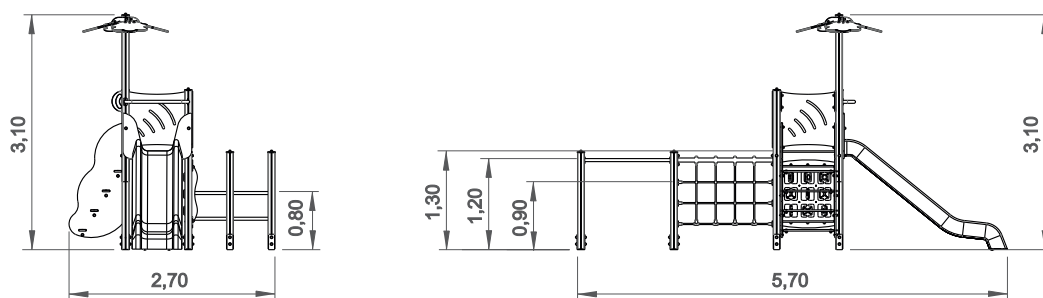



Utilização do equipamento sujeito a condições vigiadas; Zona de segurança: Área mínima requerida pela norma EN 1176-1,6
 Utilización del equipo sujeto a condiciones vigiladas; Zona de seguridad: Área mínima requerida por la norma EN 1176-1,6
 Use of equipment subject to supervised conditions; Safety zone: Minimum area required by EN 1176-1,6
 Utilisation d'équipement soumis à des conditions supervisées; Zone de sécurité: Surface minimale requise par l'EN 1176-1,6

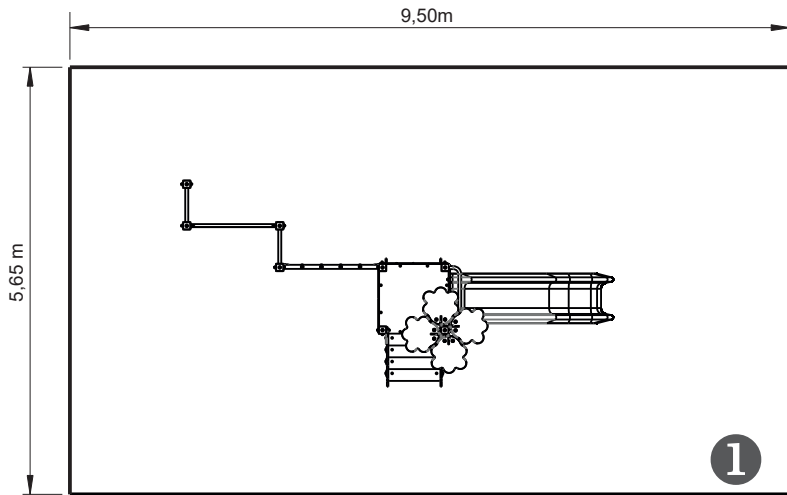

— Zona de impacto
 - - Espaço livre

EN 1176-1,3



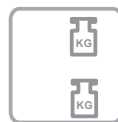
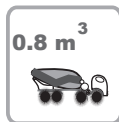

| | |
|---|------|
| | ① |
|  | 1,30 |
|  | 54 |
| | 54 |

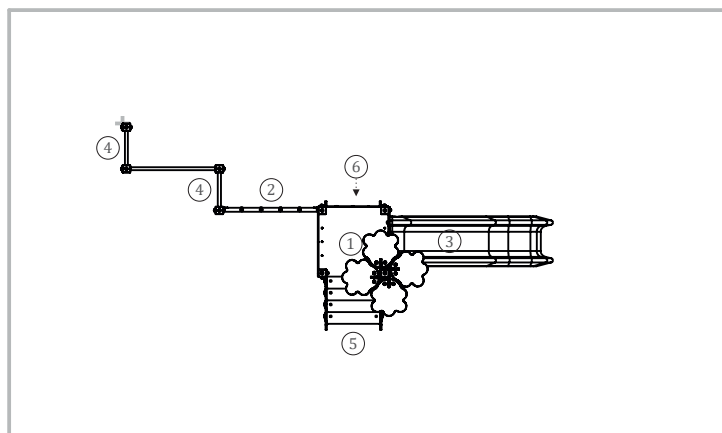

INFORMAÇÃO TÉCNICA / INFORMACIÓN TÉCNICA / TECHNICAL INFORMATION / INFORMATIONS TECHNIQUES

- 1 - Torres Simples  1.30m
- 2 - Rede Escalada  1.30m
- 3 - Escorrega  1.30m
- 4 - Escada 1,3m  0.80m
- 5 - Escada Folha  1.30m
- 6 - Jogo do Galo





Prumos

Alumínio: Perfil de 90x90x2.5mm em liga 6063 e tratamento T66, sendo esta uma liga de extrusão por excelência, apresenta uma excelente resistência à corrosão, com um bom acabamento superficial. O tratamento T66 na qual esta liga é solubilizada, temperada e envelhecida artificialmente, visa melhorar as suas propriedades mecânicas. Este é fornecido à cor natural com opção de ser lacado ao RAL que o cliente pretender;

Painéis

HDPE: Polietileno de alta densidade monocolor ou bicolor. Por ser um polímero é caracterizado pela sua resistência a produtos químicos e à corrosão. Pela sua capacidade de elasticidade e leveza, oferece alta resistência ao impacto, sendo muito difícil quebrar. A superfície antiderrapante fornece segurança para as crianças e a sua base sintética impede o cultivo de bactérias e fungos. Não necessita de qualquer manutenção;

Rede

cordas Ø16mm reforçadas em aço revestido por fibras de polipropileno, acessórios de ligação e fixação em plástico HDPE com protecção U.V., elementos de fixação em aço galvanizado a quente;

Contraplacado marítimo

antiderrapante, colado com resinas fenólicas resistentes as intempéries e raios UV. em conformidade com as normas EL 314-2/c classe 3 (DIN 68 TS TCIL3: BFU 100, BS 6566 PART 8 : WBP);

Peças de Plástico

Escorrega: polietileno de alta densidade, resistente aos raios U.V., grande resistência à rotura e máxima segurança;

Peças Metálicas

Tubos: Aço Inox AISI 304 de Ø40mm e de Ø54mm ;

Sistema de fixação

Tipo B – Sistema de fixação standard composto por base metálica aparafusada ao solo com buchas metálicas;

Tipo C – Sistema de fixação standard composto por prumo aplicado directamente no solo e chumbado com betão;

Parafusos e acessórios

Parafusos: Aço zincado ou opcionalmente aço inox AISI 304;

Cápsulas: Plástico polipropileno PP;

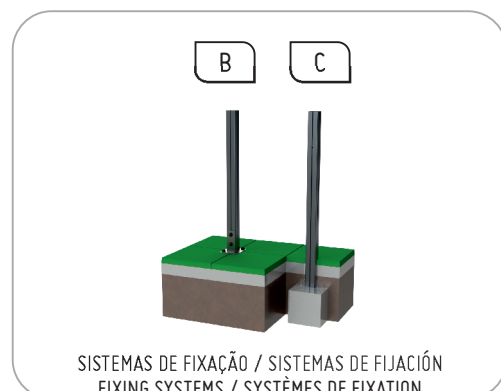



Divertir: Enquanto se divertem, as crianças adquirem imensas capacidades, desde habilidades físicas a interações sociais.



Socializar: A socialização e a imaginação são necessárias em todo o jogo. Tudo isso cria relação entre crianças e desperta o senso de convivência e a solidariedade.



Jogar: Desenvolve a paciência, a partilha e o espírito desportivo.



Trepar: Desenvolve as capacidades motrizes das crianças, o controlo do próprio corpo, o equilíbrio e a coordenação, estimulando a capacidade motora e a força nos movimentos.



Escorregar: A superfície inclinada permite que a criança deslize a grande velocidade. A sensação de velocidade fá-la sentir viva e a aprender a controlar os movimentos exercitando os reflexos e as habilidades motoras.



Postes

Aluminio: Perfil 90x90x2,5 mm con aleación 6063 y tratamiento T66, constituyendo una aleación de extrusión de alta calidad, ya que presenta una óptima resistencia a la corrosión, con un buen remate superficial. El tratamiento T66, en donde esta aleación está solubilizada, templada y envejecida artificialmente, tiene como objetivo mejorar sus propiedades mecánicas. Dicho tratamiento se proporciona al color natural con la opción de ser lacado a RAL con el color que el cliente pretenda.

paneles

HDPE: Polietileno de alta densidad, monocolor o bicolor. Al tratarse de un polímero, su resistencia a productos químicos y corrosión está garantizada. Su capacidad de elasticidad y levedad ofrece una alta resistencia a cualquier tipo de impacto, siendo muy difícil que se produzcan roturas. Su superficie antideslizante ofrece a los niños una alta seguridad y su base sintética impide el desarrollo de bacterias y hongos. No necesita ningún tipo de mantenimiento.

red

Cuerdas \varnothing 16 mm reforzadas con acero revestido con fibras de polipropileno, accesorios de enlace y fijación de plástico HDPE con protección U.V., elementos de sujeción de acero galvanizado en caliente.

Madera contrachapada marítima

Antiderrapante, pegado con resinas fenólicas resistentes a la intemperie y los rayos UV. de conformidad con las normas EL 314-2 / clase 3 (DIN 68 TS TCIL3: BFU 100, BS 6566 PART 8: WBP);

Piezas de plástico

Tobogán: polietileno de alta densidad, resistente a los rayos U.V., gran resistencia a la rotura y máxima seguridad;

Piezas Metálicas

Acero Inoxidable: AISI 304 de \varnothing 40 mm y de \varnothing 54 mm.

Sistema de fijación

Permite la colocación en el suelo sin que la madera entre en contacto con la tierra. La parte inferior de los sistemas de fijación se anclan en el suelo; estando fabricados en chapa de acero galvanizado:

TIPO B – Sistema de fijación estándar compuesto por una base metálica atornillada al suelo con casquillos de metal.

TIPO C – Sistema de fijación estándar compuesto por plomo aplicado directamente al suelo y plomado con hormigón.

Tornillería y accesorios

Tornillos: Acero galvanizado electrolítico u opcionalmente acero inoxidable AISI 304;

Cápsulas: Plástico de polipropileno PP;

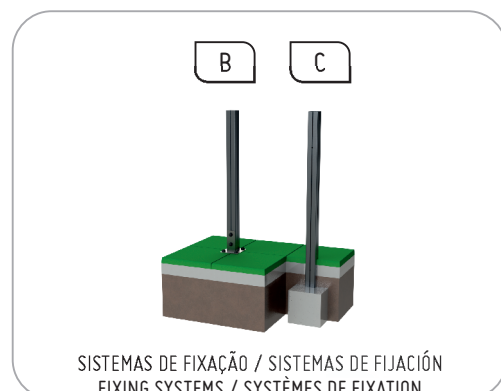



Divertir: Mientras se divierten, los niños adquieren inmensas capacidades, desde habilidades físicas a interacciones sociales.



Socializar: La socialización y la imaginación son necesarias en todo el juego. Todo esto crea relación entre niños y despierta el sentido de convivencia y la solidaridad.



Jugar: Desarrolla la paciencia, el compartir y el espíritu deportivo.



Trepar: Desarrolla las capacidades motrices de los niños, el control del propio cuerpo, el equilibrio y la coordinación, estimulando la capacidad motora y la fuerza en los movimientos.



Escurrir: La superficie inclinada permite que el niño deslice a gran velocidad. La sensación de velocidad la hace sentir viva y aprender a controlar los movimientos ejercitando los reflejos y las habilidades motoras.



Plums

Aluminum: Profile of 90x90x2.5mm in alloy 6063 and T66 treatment, this is an extrusion alloy par excellence, presents an excellent resistance to corrosion, with a good surface finish. The T66 treatment in which this alloy is solubilized, tempered and artificially aged, aims to improve its mechanical properties. This is supplied to the natural color with the option of being lacquered to the RAL that the customer wants;

Panels

HDPE: High density polyethylene mono or two color. Being a polymer is characterized by its resistance to chemicals and corrosion. Due to its elasticity and lightness, it offers high impact resistance and is very difficult to break. The non-slip surface provides safety for children and its synthetic base prevents the growth of bacteria and fungi. It does not require any maintenance;

Net

ropes Ø16mm reinforced in steel covered by polypropylene fibers, fittings and connection in HDPE plastic with U.V. protection, fastening elements in hot galvanized steel;

Marine Plywood

anti-slip, bonded with weather resistant phenol resins and UV rays. in accordance with standards EL 314-2 / class 3 (DIN 68 TS TCIL3: BFU 100, BS 6566 PART 8: WBP);

Plastic parts

Slide: high density polyethylene, resistant to UV rays, high breaking strength and maximum safety;

Metal parts

Pipes: Stainless steel AISI 304 of Ø40mm and Ø54mm;

Fixation System

Type B – Standard fastening system consisting of metal base bolted to the ground with metal bushings;

Type C – Standard fixing system composed of plumbing applied directly to the ground and cast with concrete;

Screws and accessories

Screws: Zinc-plated steel or optionally AISI 304 stainless steel;

Capsules: PP polypropylene plastic;

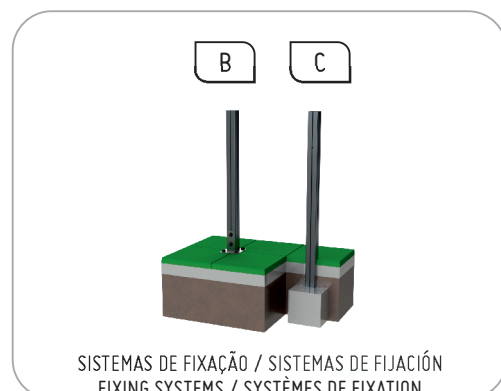



Fun: While having fun, children acquire immense abilities, from physical abilities to social interactions.



Socializing: Socialization and imagination are necessary throughout the game. All this creates a relationship between children and awakens the sense of coexistence and solidarity.



Play: Develops patience, sharing and sporting spirit.



Climb: It develops children's motor skills, body control, balance and coordination, stimulating motor ability and strength in movements.



Sliding: The sloping surface allows the child to slide at high speed. The sensation of speed makes you feel alive and learn to control your movements by exercising reflexes and motor skills.

Poteaux

Aluminium: Le profil de 90x90x2.5mm en alliage 6063 et traitement T66, c'est un alliage d'extrusion par excellence, présente une excellente résistance à la corrosion, avec un bon état de surface. Le traitement T66 dans lequel cet alliage est solubilisé, revenu et vieilli artificiellement vise à améliorer ses propriétés mécaniques. Ceci est fourni à la couleur naturelle avec la possibilité d'être laqué au RAL que le client veut;

Panneaux

HDPE: Polyéthylène haute densité mono ou bicolore. Être un polymère se caractérise par sa résistance aux produits chimiques et à la corrosion. Grâce à son élasticité et à sa légèreté, il offre une grande résistance aux chocs et est très difficile à briser. La surface antidérapante assure la sécurité des enfants et sa base synthétique empêche la croissance des bactéries et des champignons. Il ne nécessite aucun entretien

Filet

cordes Ø16mm renforcées en acier recouvertes de fibres de polypropylène, raccords et raccords en plastique HDPE avec protection anti-UV, éléments de fixation en acier galvanisé à chaud;

Contreplaqué Marine

anti-dérapant, collé avec des résines phénoliques résistantes aux intempéries et aux rayons UV. conforme aux normes EL 314-2 / classe 3 (DIN 68 TS TCIL3: BFU 100, BS 6566 PARTIE 8: WBP);

Pièces en plastique

Glissière: polyéthylène haute densité, résistant aux rayons UV, haute résistance à la rupture et sécurité maximale;

Pièces métalliques

Tuyaux: acier inoxydable AISI 304 de Ø40mm et Ø54mm;

Système de fixation

Type B – Système de fixation standard constitué d'une base en métal boulonnée au sol avec des bagues en métal;

Type C – Système de fixation standard composé de plomberie appliquée directement sur le sol et coulée avec du béton;

Vis et accessoires

Vis: Acier zingué ou acier inoxydable AISI 304 en option;

Capsules: PP polypropylène plastique;

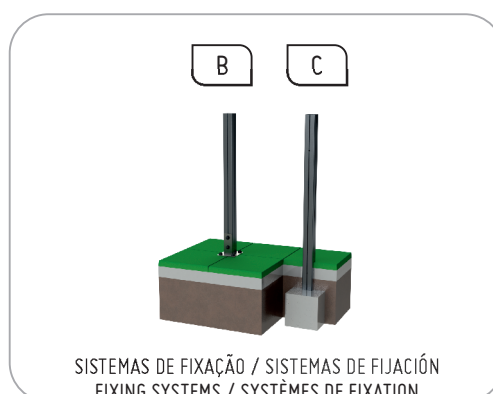



Amusement: tout en s'amusant, les enfants acquièrent d'énormes capacités, allant des capacités physiques aux interactions sociales.



Socialiser: la socialisation et l'imagination sont nécessaires tout au long du jeu. Tout cela crée une relation entre les enfants et éveille le sentiment de coexistence et de solidarité.



Jouer: Développe la patience, le partage et l'esprit sportif.



Escalade: Il développe les capacités motrices, le contrôle du corps, l'équilibre et la coordination des enfants, stimulant la capacité motrice et la force dans les mouvements.



Coulissante: la surface inclinée permet à l'enfant de glisser à grande vitesse. La sensation de vitesse vous permet de vous sentir vivant et d'apprendre à contrôler vos mouvements en exerçant des réflexes et des habiletés motrices.