

Tolerância Geral: ± 5%



13,50 m²



0,500 m



2-8



1



MEDIDAS GERAIS / MEDIDAS GENERALES / GENERAL MEASURES / MESURES GÉNÉRALES

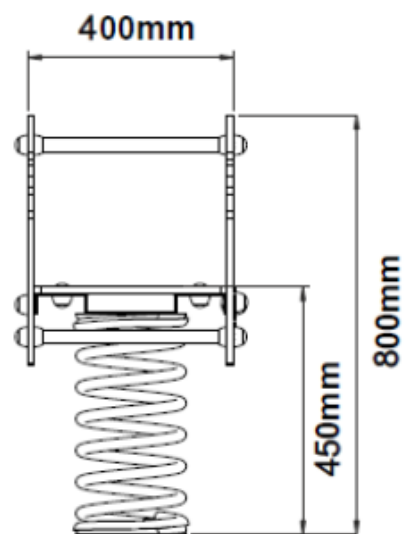
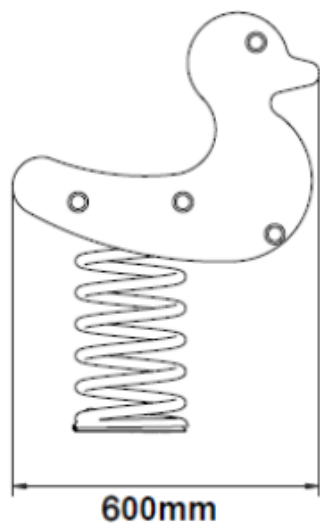

INSTALAÇÃO / INSTALACIÓN / INSTALLATION / INSTALLATION



0,15m³



01:00h



1x



0,00kg



0,00kg



1

13,50m²



0,50m

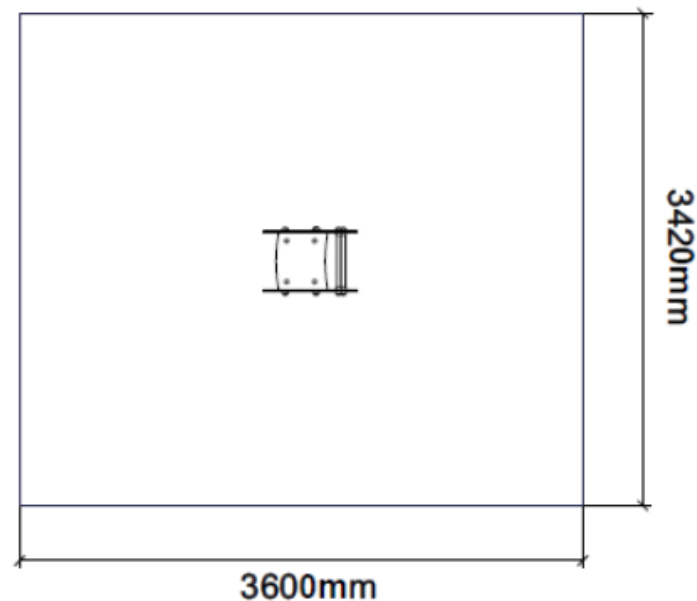



DESCRIÇÃO

Equipamento BragPLAY, mola PATOS (AQL - 0.50m), composta por 1 assento, 2 painéis laterais em forma de pato em Bragpo, 2 barras de apoio em tubo Ø25mm em aço inox, uma para as mãos e outra para os pés, 1 mola em espiral 20x180x400mm cor amarela. Ferragens em aço electrozincado. Fixação ao solo tipo X (aparafusar).

Medidas gerais (CxLxA): 600x400x800mm
Área de segurança: 12.3m² | Área livre: 3600x3420mm
Faixa etária: 2-8 anos
Nº de utilizadores: 1

CARACTERÍSTICAS TÉCNICAS

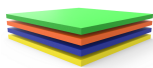

BRAGPO

BragPO HDPE de alta densidade monocolor ou bicolor, livre de HPA. Caracterizado pela sua extrema leveza e elasticidade, resistência a produtos químicos, corrosão, raios UV (UNE EN ISO 4892), alta resistência à inflamabilidade (UNE-EN ISO 11925-2) e resistência a impactos (ISO 527-1). Não necessita de qualquer manutenção.
Garantia: 15 anos

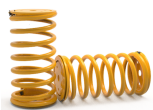

MOLA

Mola helicoidal em aço 35 SCD, com fosfatização de zinco e lacagem cor amarela resistente a UV, controlada em campo magnetoscópio.



FERRAGENS EM AÇO ELETROZINCADO

Ferragens em aço eletrozincado, protegidas por cápsulas em polipropileno PP.



TUBO AÇO INOX AISI 304

Tubo em aço inoxidável AISI 304, de acordo com a norma EN 14301, com acabamento 2B.
Garantia: 15 anos.



SISTEMA DE FIXAÇÃO

Tipo X - Sistema de fixação composto por base metálica aparafusada ao solo rígido.

A base metálica é fabricada em chapa de aço carbono, com tratamento anticorrosivo de galvanização por imersão a quente com espessura entre 120 a 140µm de acordo com a norma EN ISO 1461, que permite a sua colocação sem que o prumo entre em contacto direto com o solo. A sua fixação ao prumo é feita por um sistema de aperto rápido aumentando a longevidade do prumo e a sua fácil e rápida substituição em caso de necessidade.

FUNÇÕES LÚDICAS



PORTUGAL
www.bragmaia.com
geral@bragmaia.com

brag
PLAY

brag
URBAN

brag
SPORT

brag
SIGN

brag
LIGHT



DIVERSÃO

Enquanto se divertem, as crianças desenvolvem imensas capacidades, tais como: habilidades físicas, emocionais, sociais e motoras.



SOCIALIZAR

A importância de brincar reside no facto das brincadeiras promoverem a interação social, despertando-lhes o senso de convivência e solidariedade. Enquanto brincam, as crianças aprendem a partilhar, respeitar e ouvir os outros, desta forma iniciam a sua preparação para viver em sociedade.



JOGAR

O ato de jogar é muito mais do que uma mera brincadeira, trata-se de uma atividade, em que as crianças aliam a diversão, atividade física e interação social. É também nestes momentos, que estimulam a sua capacidade de trabalhar em equipa, algo essencial para o seu futuro pessoal, social e laboral. Ao jogar a criança desenvolve a paciência, a partilha, a concentração e o espírito desportivo.



DESENVOLVIMENTO COGNITIVO

Um aspeto importante do ato de brincar, é o desenvolvimento do raciocínio, da sua imaginação e atenção. Novas brincadeiras são essenciais para estimular a capacidade de pensar, compreender e agir, desenvolvendo o sistema cognitivo.



BALANÇAR

Este movimento proporciona o desenvolvimento do sistema nervoso, sobretudo ao nível psicomotor e da visão. Para além de ser tranquilizante, desenvolve ainda as capacidades de equilíbrio e coordenação.

NORMAS



EN 1176-1

Equipamentos e superfícies para espaços de jogo e recreio
Parte 1: Requisitos de segurança e métodos de ensaio gerais

CONFIDENCIALIDADE E PROPRIEDADE INTELECTUAL

A informação contida neste documento é confidencial, não podendo o destinatário do mesmo reproduzi-la ou permitir a terceiros que a obtenham, utilizem ou divulguem sem a prévia e expressa autorização da BRICANTEL.

Todos os direitos de propriedade intelectual sobre os desenhos e modelos apresentados são da titularidade exclusiva da BRICANTEL, sendo expressamente proibida a prática de qualquer ato de exploração dos mesmos sem o consentimento desta, nos termos do código da propriedade industrial e do código do direito de autor e dos direitos conexos. A violação da obrigação de confidencialidade e/ou dos direitos de propriedade intelectual da BRICANTEL, pode dar origem a responsabilidade civil e criminal.





DESCRIPCIÓN

Equipamiento BragPLAY, muelle PATOS (ACL: 0.50m), compuesto por 1 asiento y 2 paneles laterales en forma de pato en bragpo. 2 barras de soporte en tubo Ø25mm en acero inoxidable, una para las manos y otra para los pies. 1 muelle en espiral 20x180x400mm color amarillo. Herrajes de acero electrochapado. Fijación al suelo tipo X (atornillado).

Medidas generales (LxAxA): 600x400x800mm
Área de seguridad: 12.3m² | Área libre: 3600x3420mm
Rango de edad: 2-8 años
Número de usuarios: 1

CARACTERÍSTICAS TÉCNICAS

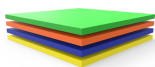

BRAGPO

BragPO HDPE de alta densidad monocolor o bicolor, sin HPA. Caracterizado por su extrema ligereza y elasticidad, resistencia a productos químicos, corrosión, rayos UV (UNE EN ISO 4892), a la inflamabilidad (UNE-EN ISO 11925-2) y al impacto (ISO 527-1). No necesita ningún tipo de mantenimiento.
Garantía: 15 años

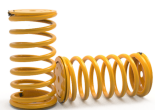

MUELLE

Muelle helicoidal en acero 35 SCD, con fosfatado de zinc y lacado, resistente a los rayos UV, controlado en campo magnetoscopio.



HERRAJES EN ACERO ELECTROCHAPADO

Herrajes en acero electrochapado, protegidos por cápsulas en polipropileno PP.

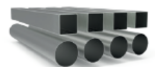

TUBO ACERO INOX AISI 304

Tubo en acero inoxidable AISI 304, según la norma EN 14301, con refinamiento 2B.
Garantía: 15 años.



SISTEMA DE FIJACIÓN

Tipo X - Sistema de fijación compuesto por una base metálica y atornillada al suelo rígido.

La base metálica es fabricada en chapa de acero al carbono, con tratamiento anticorrosivo de galvanización por inmersión en caliente con espesor entre 120 y 140µm de acuerdo con la norma EN ISO 1461, que permite su colocación sin que la viga entre en contacto directo con el suelo. Su fijación a la viga es hecha por un sistema de sujeción rápido aumentando la longevidad de la viga y su fácil y rápida sustitución en caso de necesidad.

FUNCIONES DE JUEGO



PORTUGAL
www.bragmaia.com
geral@bragmaia.com

brag
PLAY

brag
URBAN

brag
SPORT

brag
SIGN

brag
LIGHT



DIVERSIÓN

Mientras se divierten, los niños desarrollan una gran diversidad de capacidades, tales como: habilidades físicas, emocionales, sociales y motrices.



SOCIALIZAR

La importancia del juego reside en que éste, promueve la interacción social, despertando en los niños la necesidad de convivencia y solidaridad. Mientras juegan, los niños aprenden a compartir, respetar y escuchar a los demás niños. Es la mejor forma de iniciar su preparación para convivir en sociedad.



JUGAR

El simple acto de jugar es algo más que una mera diversión, se trata de una actividad en donde los niños aplican esa diversión a una actividad física, así como a interactuar socialmente. Es también en esta fase de su desarrollo, donde se estimula su capacidad de trabajar en equipo, algo primordialmente esencial para su desarrollo personal, social y laboral. Cuando juega, el niño desarrolla la paciencia, el compartir, la concentración y su espíritu deportivo.



DESARROLLO COGNITIVO

Un aspecto importante del simple acto de jugar es el desarrollo del raciocinio, de su imaginación y atención. Son esenciales nuevas diversiones, a través del juego, para estimular la capacidad de pensar, comprender y reaccionar, desarrollando así, el sistema cognitivo.



BALANCEARSE

Este movimiento proporciona el desarrollo del sistema nervioso, sobre todo a nivel psicomotor y de la visión. Además de ser tranquilizante, desarrolla todavía las capacidades de equilibrio y coordinación.

NORMAS



EN 1176-1

Equipamiento de las áreas de juego y superficies
Parte 1: Requisitos generales de seguridad y métodos de ensayo.

CONFIDENCIALIDAD Y PROPIEDAD INTELECTUAL

La información contenida en este documento es estrictamente confidencial, no pudiendo el destinatario reproducirla o permitir a terceros que la adquieran, utilicen o divulguen sin la previa y expresa autorización de BRICANTEL. Todos los derechos de propiedad intelectual sobre los diseños y modelos presentados son de titularidad exclusiva de BRICANTEL, estando expresamente prohibida la práctica de cualquier acto de usurpación de los mismos sin el previo consentimiento de la empresa, dentro de los términos del código de propiedad industrial y del código de derechos de autor y derechos análogos. La violación de la obligación de confidencialidad y/o de los derechos de propiedad intelectual de BRICANTEL, puede dar origen a responsabilidad civil y criminal.





DESCRIPTION

BragPLAY Equipment, spring PATOS (FFH: 0.45m), composed of 1 seat and 2 side panels in the shape of a duck in bragpo, 2 support bars in stainless steel Ø25mm tube, one for the hands and one for the feet, 1 spring in spiral 20x180x400mm yellow. Type X ground attachment (screw).

General measures (LxWxH): 600x400x800mm
Security area: 12.3m² | Free area: 3600x3420mm
Age group: 2-8 years old
Number of users: 1

TECHNICAL FEATURES

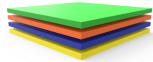

BRAGPO

BragPO HDPE of high density in one color or bicolor, free of HPA. Characterized by its extreme lightness and elasticity, resistance to chemicals, corrosion, UV rays (UNE EN ISO 4892), to flammability (UNE-EN ISO 11925-2) and impact (ISO 527-1). It doesn't need any maintenance.
Guarantee: 15 years.

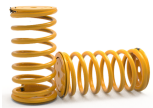

SPRING

Helical spring in 35 SCD steel, with zinc phosphating and UV resistant lacquer, controlled in a magnetoscope field.



STEEL ELECTROPLATED HARDWARE

Steel electroplated hardware, protected by polypropylene PP capsules.

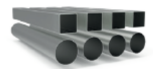

STAINLESS STEEL TUBE AISI 304

Tube in stainless steel AISI 304, according to EN 14301, with finish 2B.
Guarantee: 15 years.



FIXATION SYSTEM

Type X - Fixation system composed of a metal base bolted to the hard ground.

The metal base is made of carbon steel sheet, with corrosion-resistant hot-dip galvanisation treatment of between 120 and 140µm thickness according to EN ISO 1461, which allows its placement without the plumb in direct contact with the ground. Its attachment to the plumb line is made by a quick clamping system increasing the longevity of the plumb line and its easy and fast replacement in case of need.



PLAY FUNCTIONS



FUN

While having fun, children acquire immense abilities, from physical abilities to social interactions.



SOCIALIZING

Socialization and imagination are necessary throughout the game. All this creates a relationship between children and awakens the sense of coexistence and solidarity.



PLAY

The act of playing is more than a diversion, it's an activity, in which children combine fun, physical activity and social interaction, It's also in these moments that they stimulate their ability to work as a team, something essential for their personal, social and working future. By playing the child develops patience, sharing, concentration and a sporting spirit.



COGNITIVE DEVELOPMENT

An important aspect of play is the development of reasoning, imagination and attention. New games are essential to stimulate the ability to think, understand and act, developing the cognitive system.



SWING

This movement develops the nervous system, especially at the psychomotor and vision level. In addition to being tranquilizer, it also develops the skills of balance and coordination.



STANDARTS



EN 1176-1
Playground equipment and surfacing
Part 1: General safety requirements and test methods

CONFIDENTIALITY AND INTELLECTUAL PROPERTY

The information contained in this document is confidential, and the recipient cannot reproduce it or allow third parties to obtain, use or disclose it without the prior and express authorization of BRICANTEL.
All intellectual property rights over the designs and models presented are the exclusive property of BRICANTEL, and the practice of any act of exploitation thereof without the consent of the latter, under the terms of the industrial property code and the copyright code and related rights. Violation of BRICANTEL's obligation of confidentiality and / or intellectual property rights may give rise to civil and criminal liability.



PORTUGAL
www.bragmaia.com
geral@bragmaia.com

brag **PLAY** brag **URBAN** brag **SPORT** brag **SIGN** brag **LIGHT**



DESCRIPTION

Equipement BragPLAY, ressort PATOS (HCL: 0.55m), composé d'un siège et de 2 panneaux latéraux en forme de canard en bragpo, 2 barres de support en tube Ø25mm en acier inoxydable, une pour les mains et une autre pour les pieds, 1 ressort spirale 20x180x44mm couleur jaune. Ferrures en acier électrozingué. Fixation au sol type X (fixé).

Mesures générales (LxLxH): 600x400x800mm
Zone de sécurité: 12.3m2 | Zone libre: 3600x3420mm
Tranche d'âge: 2-8 ans
Nombre d'utilisateurs: 1

CARACTÉRISTIQUES TECHNIQUES

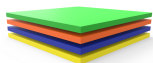

BRAGPO

BragPO HDPE d'une couleur ou bicolore de haute densité, sans HPA. Caractérisé par son extrême légèreté et élasticité, résistante aux produits chimiques, à la corrosion, aux rayons UV (UNE EN ISO 4892), à l'inflammabilité (UNE-EN ISO 11925-2) et aux impacts (ISO 527-1). Pas d'entretien nécessaire.
Garantie: 15 ans.

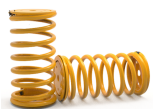

RESSORT

Ressort hélicoïdal en acier 35 SCD, avec phosphatation de zinc et vernis résistant aux UV, contrôlé dans un champ de magnétoscope.



FERRURES EN ACIER ELECTROZINGÉ

Ferrures en acier electrozingué, protégé para des capsules en polypropylène PP.

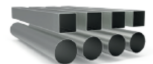

TUBE EN ACIER INOXYDABLE AISI 304

Tube en acier inoxydable AISI 304, en accord avec la norme EN 14301, avec finition 2B.
Garantie: 15 ans.



SISTÈME DE FIXATION

Type X - Système de fixation composé d'une base métallique fixée au sol rigide.

La base métallique est fabriquée en tôle d'acier carbone, avec un traitement anticorrosion par galvanisation par immersion à chaud d'une épaisseur comprise entre 120 et 140µm selon la norme EN ISO 1461, qui permet sa pose sans que la poutre rentre en contact direct avec le sol. Sa fixation à la poutre est réalisée par un système de serrage rapide augmentant sa longévité et facilitant son remplacement, qui sera rapide en cas de besoin.



FONCTIONS DE JEU



AMUSEMENT

En s'amusant, les enfants développent plusieurs capacités telles que des habilités physiques, émotionnelles, sociales et motrices.



SOCIALES

L'importance de jouer se note dans l'interaction sociale que nécessitent ces activités, réveillant en eux le sens de la convivialité et de la solidarité. En jouant, les enfants apprennent à partager, respecter, et écouter autrui. De cette manière, ils débutent leur apprentissage en vie de société.



JOUER

Jouer n'est pas une simple plaisanterie, il s'agit d'une activité où les enfants peuvent allier diversion, activité physique et interaction sociale. C'est aussi dans ces moments qu'ils stimulent leur capacité à travailler en équipe, qualité essentielle pour sa vie future tant sur le plan personnelle, social et professionnelle. En jouant, l'enfant développe sa patience, sa concentration et son esprit de partage et sportif.



DÉVELOPPEMENT COGNITIF

Un aspect importante lors de la diversion des enfants, c'est le développement de leurs sens, imagination et attention. De nouveaux jeux sont essentiels pour stimuler leurs capacités à penser, comprendre et agir.



VACILLER

Ce mouvement appelle le système nerveux à entrer en jeu. En effet, les enfants auront besoin de le solliciter afin de tenir en équilibre. En plus d'être tranquilisant, il aide au développement de la coordination.



NORMES



EN 1176-1
Équipements et sols d'aires de jeux
Partie 1: Exigences de sécurité et méthodes d'essai générales

CONFIDENTIALITÉ ET PROPRIÉTÉ INTELLECTUELLE

Les informations contenues dans ce document sont confidentielles et le destinataire ne peut pas les reproduire ni permettre à des tiers de les obtenir, de les utiliser ou de les divulguer sans l'autorisation préalable et expresse de BRICANTEL.
Tous les droits de propriété intellectuelle sur les dessins et modèles présentés sont propriété exclusive de BRICANTEL, et la pratique d'un acte d'exploitation de ceux-ci sans le consentement de cette dernière, selon les termes du code de la propriété industrielle et du code du droit d'auteur et des droits voisins. La violation de l'obligation de confidentialité et / ou des droits de propriété intellectuelle de BRICANTEL peut engager à la responsabilité civile et pénale.



PORTUGAL
www.bragmaia.com
geral@bragmaia.com

brag
PLAY

brag
URBAN

brag
SPORT

brag
SIGN

brag
LIGHT

Informação sujeita a alterações sem aviso prévio.

Data de exportação: 25/03/2023