





PEIXE-LUA

ELMOL004



			
12,6m ²	0,54m	2-8	01

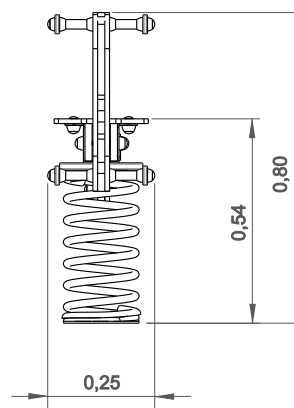
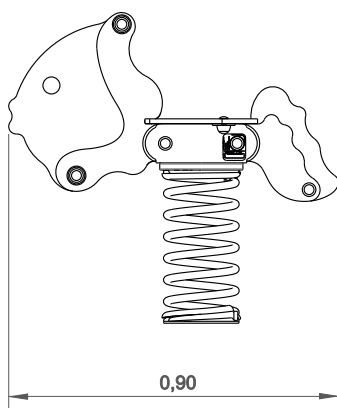



Utilização do equipamento sujeito a condições vigiadas; Zona de segurança: Área mínima requerida pela norma EN 1176-1,6
 Utilización del equipo sujeto a condiciones vigiladas; Zona de seguridad: Área mínima requerida por la norma EN 1176-1,6
 Use of equipment subject to supervised conditions; Safety zone: Minimum area required by EN 1176-1,6
 Utilisation d'équipement soumis à des conditions supervisées; Zone de sécurité: Surface minimale requise par l'EN 1176-1,6

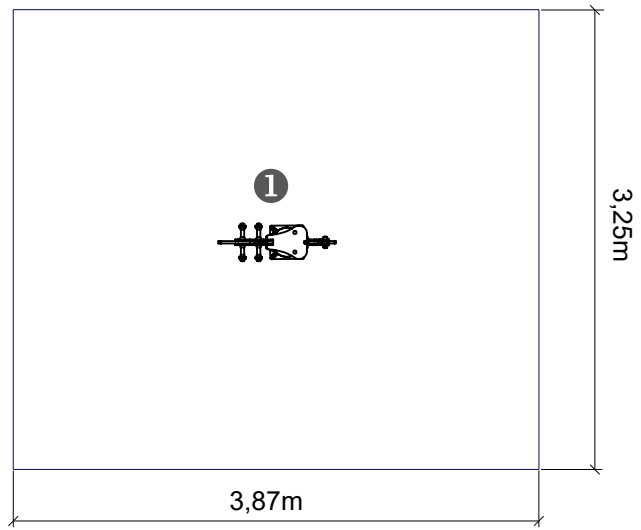

— Zona de impacto
 - - Espaço livre

EN 1176-1,6 



.....	①
	0,54
	12.6
m ²	12.6



1 - Mola  0.54m

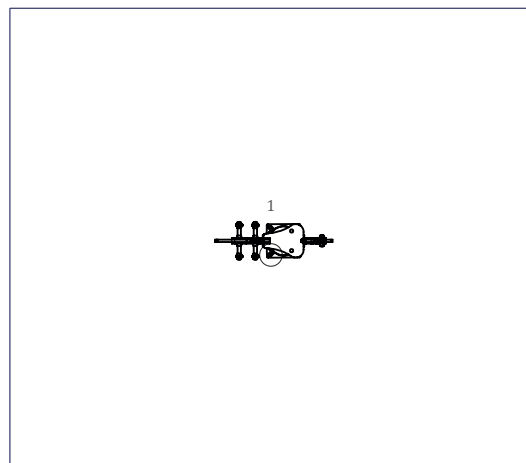



Painéis

HDPE: Polietileno de alta densidade monocolor ou bicolor. Por ser um polímero é caracterizado pela sua resistência a produtos químicos e à corrosão. Pela sua capacidade de elasticidade e leveza, oferece alta resistência ao impacto, sendo muito difícil quebrar. A superfície antiderrapante fornece segurança para as crianças e a sua base sintética impede o cultivo de bactérias e fungos. Não necessita de qualquer manutenção;

Peças Metálicas

Mola: Mola helicoidal em aço 35 SCD controlada em campo magnetoscópico. A superfície é tratada em jacto de areia e posteriormente com capas de preparação de zinco e duas capas de pó de poliéster de 100microns;

Tubos

Aço Inox AISI 304 de Ø25mm;

Ferro: Tratamento anticorrosivo de galvanização por imersão a quente de acordo com a norma EN ISO 1461. Lacagem a esmalte Tipo gel a 230°C, com espessura entre 50 a 70µm, de acordo com a norma UNE EN ISO 2808;

Sistema de fixação

Tipo A – Sistema de fixação standard composto por base metálica embutida no solo e chumbada com betão;

Tipo B – Sistema de fixação standard composto por base metálica aparafusada ao solo com buchas metálicas;

Parafusos e acessórios

Parafusos: Aço zincado ou opcionalmente aço inox AISI 304;

Cápsulas: Plástico polipropileno PP;

100%

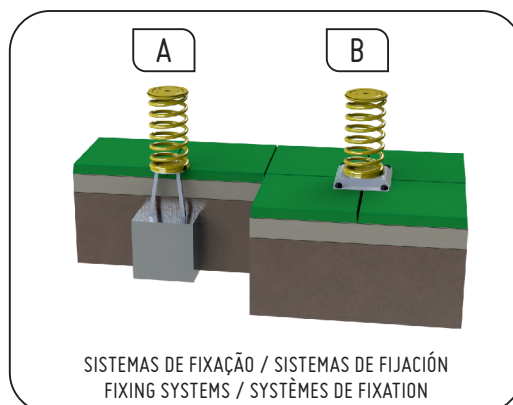

FUNÇÕES LÚDICAS/ FUNCIONES LÚDICAS / RECREATIONAL FUNCTIONS / FONCTIONS RÉCRÉATIVES



Divertir

Enquanto se divertem, as crianças adquirem imensas capacidades, desde habilidades físicas a interações sociais.



Socializar

A socialização e a imaginação são necessárias em todo o jogo. Tudo isso cria relação entre crianças e desperta o senso de convivência e a solidariedade.



Jogar

Desenvolve a paciência, a partilha e o espírito desportivo.



Baloiçar

Esta ação ajuda a desenvolver o equilíbrio da criança e lhe ensina como controlar os movimentos com o balanço certo e vigor, o que melhora a actividade psicomotora e coordenação do corpo.





Paneles

HDPE: Polietileno de alta densidad monocolor o bicolor. Por ser un polímero se caracteriza por su resistencia a los productos químicos y a la corrosión. Por su capacidad de elasticidad y ligereza, ofrece alta resistencia al impacto, siendo muy difícil romper. La superficie antideslizante proporciona seguridad para los niños y su base sintética impide el cultivo de bacterias y hongos. No necesita mantenimiento;

Piezas Metálicas

Resorte: Resorte helicoidal en acero 35 SCD controlado en campo magnético. La superficie es tratada en chorro de arena y posteriormente con capas de preparación de cinc y dos capas de polvo de poliéster de 100 micrones;

Tuberías

Acero Inox AISI 304 de Ø25mm;

Hierro: Tratamiento anticorrosivo de galvanización por inmersión en caliente de acuerdo con la norma EN ISO 1461. Lacado a esmalte Tipo gel a 230°C, con espesor entre 50 a 70µm, de acuerdo con la norma UNE EN ISO 2808;

Sistema de fijación

Tipo A – Sistema de fijación estándar compuesto por base metálica embutida en el suelo y plomada con hormigón;

Tipo B – Sistema de fijación estándar compuesto por base metálica atornillada al suelo con tacos metálicos;

Tornillos y accesorios

Tornillos: Acero zincado o opcionalmente acero inoxidable AISI 304;

Cápsulas: Plástico o polipropileno PP;

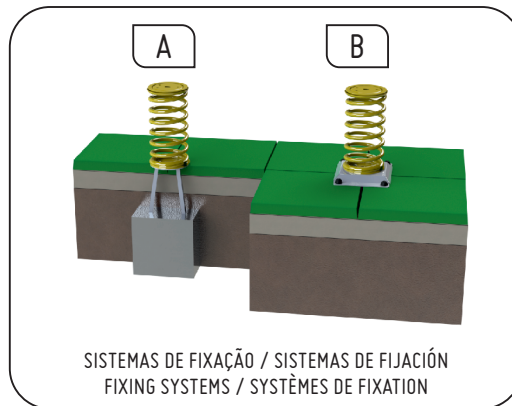

FUNÇÕES LÚDICAS/ FUNCIONES LÚDICAS / RECREATIONAL FUNCTIONS / FONCTIONS RÉCRÉATIVES



Divertir

Mientras se divierten, los niños adquieren inmensas capacidades, desde habilidades físicas a interacciones sociales.



Socializar

La socialización y la imaginación son necesarias en todo el juego. Todo esto crea relación entre niños y despierta el sentido de convivencia y la solidaridad.



Jugar

Desarrolla la paciencia, el compartir y el espíritu deportivo.



Balancín

Esta acción ayuda a desarrollar el equilibrio del niño y le enseña cómo controlar los movimientos con el balance correcto y vigor, lo que mejora la actividad psicomotora y la coordinación del cuerpo.





Panels

HDPE: High density polyethylene mono or two color. Being a polymer is characterized by its resistance to chemicals and corrosion. Due to its elasticity and lightness, it offers high impact resistance and is very difficult to break. The non-slip surface provides safety for children and its synthetic base prevents the growth of bacteria and fungi. It does not require any maintenance;

Metal Parts

Spring: Helical spring in steel 35 SCD controlled in magnetoscopic field. The surface is sandblasted and then coated with zinc plating and two layers of 100 micron polyester powder;

Tubes

Stainless steel AISI 304 Ø25mm;

Iron: Anticorrosive hot dip galvanizing treatment according to EN ISO 1461. Lacquering Type gel enamel at 230°C, with thickness between 50 and 70µm, according to the norm UNE EN ISO 2808;

Fixation System

Type A – Standard fixing system composed of metal base embedded in the ground and cast with concrete;

Type B – Standard fastening system consisting of metal base bolted to the ground with metal bushings;

Screws and accessories

Screws: Zinc-plated steel or optionally AISI 304 stainless steel;

Capsules: PP polypropylene plastic;

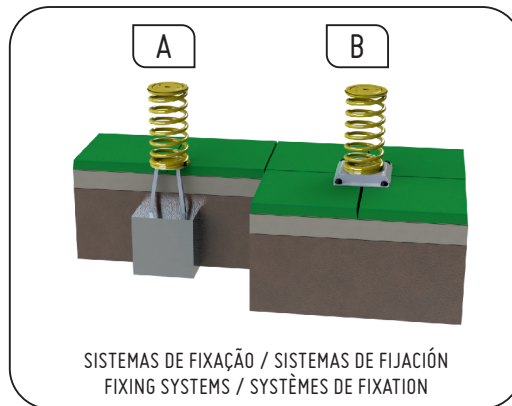

Fun

While having fun, children acquire immense abilities, from physical abilities to social interactions.



Socializing

Socialization and imagination are necessary throughout the game. All this creates a relationship between children and awakens the sense of coexistence and solidarity.



Play

Develops patience, sharing and sporting spirit.



Swing

This action helps to develop child balance and teaches you how to control movements with the right balance and vigor, which improves psychomotor activity and coordination of the body.



Panneaux

PEHD: polyéthylène haute densité mono ou bicouleur. Être un polymère se caractérise par sa résistance aux produits chimiques et à la corrosion. En raison de son élasticité et de sa légèreté, il offre une résistance élevée aux chocs et est très difficile à casser. La surface antidérapante fournit la sécurité pour les enfants et sa base synthétique empêche la croissance des bactéries et des champignons. Il ne nécessite aucun entretien.

Pièces Métalliques

Ressort: Ressort hélicoïdal en acier 35 SCD contrôlé en champ magnétoscopique. La surface est sablée puis revêtue de zinc et de deux couches de poudre de polyester de 100 microns;

Tubes

Acier inoxydable AISI 304 Ø25mm;

Fer: Traitement anticorrosion par galvanisation à chaud conforme à la norme EN ISO 1461. Type de laque email de gel à 230°C, d'une épaisseur comprise entre 50 et 70µm, selon la norme UNE EN ISO 2808;

Système de fixation

Type A – Système de fixation standard composé de base métallique encastrée dans le sol et coulé avec du béton;

Type B – Système de fixation standard constitué d'une base métallique boulonnée au sol avec des bagues métalliques;

Vis et accessoires

Vis: en acier zingué ou en acier inoxydable AISI 304 en option;

Capsules: polypropylène PP;

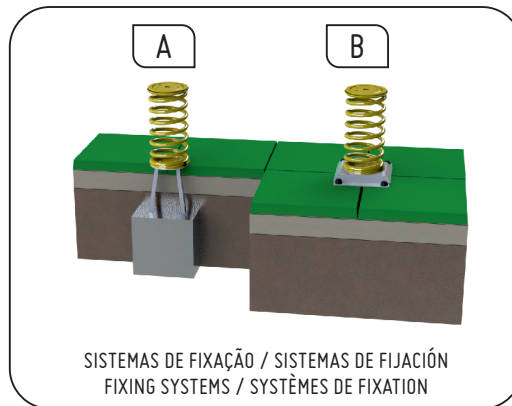

Amusement

Tout en s'amusant, les enfants acquièrent d'immenses capacités, des capacités physiques aux interactions sociales.



Socialiser

La socialisation et l'imagination sont nécessaires tout au long du jeu. Tout cela crée une relation entre les enfants et éveille le sens de la coexistence et de la solidarité.



Jeu

Développe la patience, le partage et l'esprit sportif.



Balancé

Cette action aide à développer l'équilibre de l'enfant et vous apprend à contrôler les mouvements avec le bon équilibre et la bonne vigueur, ce qui améliore l'activité psychomotrice et la coordination du corps.

