

Tolerância Geral:  $\pm 5\%$



15,00 m<sup>2</sup>



0,60 m



2-8



4



**MEDIDAS GERAIS / MEDIDAS GENERALES / GENERAL MEASURES / MESURES GÉNÉRALES**

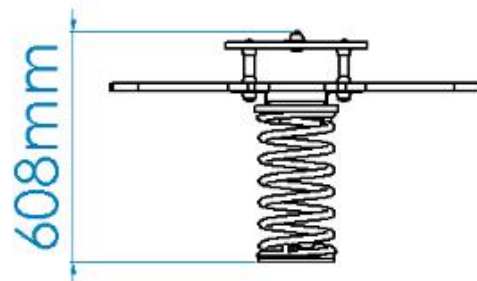

**INSTALAÇÃO / INSTALACIÓN / INSTALLATION / INSTALLATION**



0,09m<sup>3</sup>



01:00h



2x



4,00kg



16,50kg



1

15,00m<sup>2</sup>



0,60m

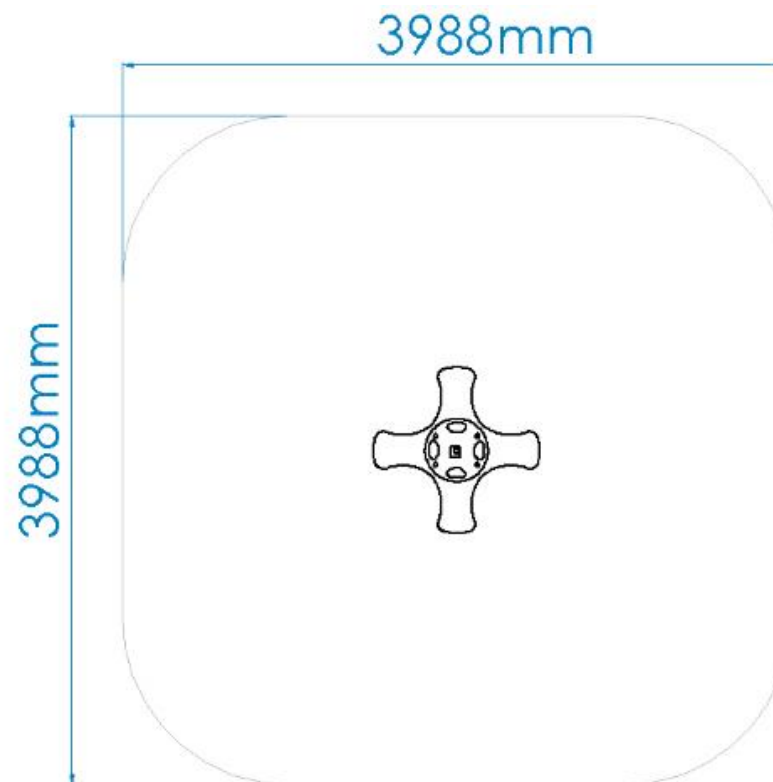



## DESCRIÇÃO

Equipamento BragPLAY, mola O Quadruplo (AQL - 0.60m), composto por 1 assento quadruplo em contraplacado marítimo antiderrapante castanho com 4 tubos em aço inox fixados a 1 painel redondo em Bragpo com 4 aberturas para criar vários apoios de mãos. Uma mola em espiral 20x180x400mm cor amarela.

Ferragens em aço eletrozincado.

Fixação ao solo tipo Y (chumbar).

Medidas gerais (CxLxA): 988x988x608mm

Área de segurança: 15m<sup>2</sup> | Área livre: 3988x3988mm

Faixa etária: 2-8 anos

Nº de utilizadores: 4

## CARACTERÍSTICAS TÉCNICAS

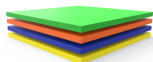

### BRAGPO

BragPO HDPE de alta densidade monocolor ou bicolor, livre de HPA. Caracterizado pela sua extrema leveza e elasticidade, resistência a produtos químicos, corrosão, raios UV (UNE EN ISO 4892), alta resistência à inflamabilidade (UNE-EN ISO 11925-2) e resistência a impactos (ISO 527-1). Não necessita de qualquer manutenção.

Garantia: 15 anos

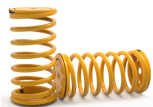

### MOLA

Mola helicoidal em aço 35 SCD, com fosfatização de zinco e lacagem cor amarela resistente a UV, controlada em campo magnetoscópio.



### FERRAGENS EM AÇO ELETROZINCADO

Ferragens em aço eletrozincado, protegidas por cápsulas em polipropileno PP.



### SISTEMA DE FIXAÇÃO

Tipo Y - Sistema de fixação composto por base metálica embutida ou por prumos aplicado diretamente no solo e chumbada com betão.

A base metálica embutida é fabricada em chapa de aço carbono, com tratamento anticorrosivo de galvanização por imersão a quente com espessura entre 120 a 140µm de acordo com a norma EN ISO 1461, que permite a sua colocação sem que o prumo entre em contacto direto com o solo. A sua fixação ao prumo é feita por um sistema de aperto rápido aumentando a longevidade do prumo e a sua fácil e rápida substituição em caso de necessidade.



## FUNÇÕES LÚDICAS



### DIVERSÃO

Enquanto se divertem, as crianças desenvolvem imensas capacidades, tais como: habilidades físicas, emocionais, sociais e motoras.



### SOCIALIZAR

A importância de brincar reside no facto das brincadeiras promoverem a interação social, despertando-lhes o senso de convivência e solidariedade. Enquanto brincam, as crianças aprendem a partilhar, respeitar e ouvir os outros, desta forma iniciam a sua preparação para viver em sociedade.



### ESTIMULAÇÃO VISUAL

É através da estimulação visual, que as crianças adquirem estímulos essenciais que vão impulsionar o desenvolvimento do seu campo visual. Assim, é essencial que estas desenvolvam uma visão funcional, que as permita brincar, socializar para interiorizar informações do meio que as rodeia e desenvolver competências.



### ESTIMULAÇÃO TÁTIL

É através do ato de brincar que se consegue estimular o sistema tátil de uma forma fácil e simples, a introdução de objetos com diferentes texturas permite que as crianças comecem a utilizar as mãos e desta forma, despertar a sua perceção sensorial tátil.



### DESENVOLVIMENTO COGNITIVO

Um aspeto importante do ato de brincar, é o desenvolvimento do raciocínio, da sua imaginação e atenção. Novas brincadeiras são essenciais para estimular a capacidade de pensar, compreender e agir, desenvolvendo o sistema cognitivo.



### BALANÇAR

Este movimento proporciona o desenvolvimento do sistema nervoso, sobretudo ao nível psicomotor e da visão. Para além de ser tranquilizante, desenvolve ainda as capacidades de equilíbrio e coordenação.

## NORMAS



### EN 1176-1

Equipamentos e superfícies para espaços de jogo e recreio  
Parte 1: Requisitos de segurança e métodos de ensaio gerais



### EN 1176-6

Equipamentos e superfícies para espaços de jogo e recreio  
Parte 6: Requisitos de segurança e métodos de ensaio adicionais, específicos para equipamentos oscilantes

## CONFIDENCIALIDADE E PROPRIEDADE INTELECTUAL

A informação contida neste documento é confidencial, não podendo o destinatário do mesmo reproduzi-la ou permitir a terceiros que a obtenham, utilizem ou divulguem sem a prévia e expressa autorização da BRAGMAIA.

Todos os direitos de propriedade intelectual sobre os desenhos e modelos apresentados são da titularidade exclusiva da BRAGMAIA, sendo expressamente proibida a prática de qualquer ato de exploração dos mesmos sem o consentimento desta, nos termos do código da propriedade industrial e do código do direito de autor e dos direitos conexos. A violação da obrigação de confidencialidade e/ou dos direitos de propriedade intelectual da BRAGMAIA, pode dar origem a responsabilidade civil e criminal.





## DESCRIPCIÓN

Equipamiento BragPLAY, muelle "CUÁDRUPLE" (HIC - 0.60m). Compuesto por 1 asiento cuádruple en contrachapado marino antideslizante marrón compuesto por 4 tubos de acero Inox fijados a 1 panel redondo en Bragpo con 4 aperturas para crear varios apoyos de manos. Un muelle de 20x180x400mm color amarillo.

Herrajes de acero electrocincado.

Fijación al suelo Tipo Y (hormigonado).

Medidas generales (LxAnxA): 988x988x608mm

Área de seguridad: 15m<sup>2</sup> | Área libre: 3988x3988mm

Rango de edad: 2-8 años

Nº de usuarios: 4 niños

## CARACTERÍSTICAS TÉCNICAS

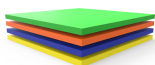

### BRAGPO

BragPO HDPE de alta densidad monocolor o bicolor, sin HPA. Caracterizado por su extrema ligereza y elasticidad, resistencia a productos químicos, corrosión, rayos UV (UNE EN ISO 4892), a la inflamabilidad (UNE-EN ISO 11925-2) y al impacto (ISO 527-1). No necesita ningún tipo de mantenimiento.

Garantía: 15 años

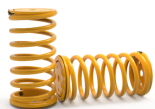

### MUELLE

Muelle helicoidal en acero 35 SCD, con fosfatado de zinc y lacado, resistente a los rayos UV, controlado en campo magnetoscopio.



### HERRAJES EN ACERO ELECTROCHAPADO

Herrajes en acero electrochapado, protegidos por cápsulas en polipropileno PP.



### SISTEMA DE FIJACIÓN

Tipo Y - Sistema de fijación estándar compuesto por una base metálica o poste embutido al suelo y con relleno de hormigón.

La base metálica incorporada está fabricada en chapa de acero de carbono, con tratamiento anticorrosivo por inmersión en caliente de 120 a 140µm de espesor según EN ISO 1461, que permite su colocación sin que el poste entre en contacto directo con el suelo. Su fijación a al poste se realiza por un sistema de sujeción rápido aumentando la longevidad del poste y su fácil y rápida sustitución en caso de necesidad.



## FUNCIONES DE JUEGO



### DIVERSIÓN

Mientras se divierten, los niños desarrollan una gran diversidad de capacidades, tales como: habilidades físicas, emocionales, sociales y motrices.



### SOCIALIZAR

La importancia del juego reside en que éste, promueve la interacción social, despertando en los niños la necesidad de convivencia y solidaridad. Mientras juegan, los niños aprenden a compartir, respetar y escuchar a los demás niños. Es la mejor forma de iniciar su preparación para convivir en sociedad.



### ESTIMULACIÓN VISUAL

A través de la estimulación visual, los niños adquieren incentivos esenciales que van a aumentar el desarrollo de su campo visual. De esta manera, es primordial que ellos desarrollen una visión funcional que les permita jugar y socializar para interiorizar informaciones del medio que los rodea, así como a desarrollar capacidades.



### ESTIMULACIÓN TÁCTIL

A través del acto del juego se consigue estimular el sentido táctil de una forma fácil y simple. La introducción de objetos con diferentes texturas permite que los niños comiencen a utilizar las manos, y de esta forma, se despierte su percepción sensorial táctil.



### DESARROLLO COGNITIVO

Un aspecto importante del simple acto de jugar es el desarrollo del raciocinio, de su imaginación y atención. Son esenciales nuevas diversiones, a través del juego, para estimular la capacidad de pensar, comprender y reaccionar, desarrollando así, el sistema cognitivo.



### BALANCEARSE

Este movimiento proporciona el desarrollo del sistema nervioso, sobre todo a nivel psicomotor y de la visión. Además de ser tranquilizante, desarrolla todavía las capacidades de equilibrio y coordinación.

## NORMAS



### EN 1176-1

Equipamiento de las áreas de juego y superficies  
Parte 1: Requisitos generales de seguridad y métodos de ensayo.



### EN 1176-6

Equipamiento de las áreas de juego y superficies  
Parte 6: Requisitos de seguridad y métodos de ensayo adicionales específicos para balancines

## CONFIDENCIALIDAD Y PROPIEDAD INTELECTUAL

La información contenida en este documento es estrictamente confidencial, no pudiendo el destinatario reproducirla o permitir a terceros que la adquieran, utilicen o divulguen sin la previa y expresa autorización de BRAGMAIA.

Todos los derechos de propiedad intelectual sobre los diseños y modelos presentados son de titularidad exclusiva de BRAGMAIA, estando expresamente prohibida la práctica de cualquier acto de usurpación de los mismos sin el previo consentimiento de la empresa, dentro de los términos del código de propiedad industrial y del código de derechos de autor y derechos análogos. La violación de la obligación de confidencialidad y/o de los derechos de propiedad intelectual de BRAGMAIA, puede dar origen a responsabilidad civil y criminal.





## DESCRIPTION

BragPLAY equipment, Spring "quadruple" (FFH-0,60m), composed of 1 quadruple seat in brown antislip marine plywood with 4 fixed stainless steel tubes to round BragPO panel with 4 openings to create multiple hands supports. One spiral spring 20x180x400mm in yellow.  
Hardware in electro-zinc steel.  
Ground fixing type Y (in-ground).

General measures (LxWxH): 988x988x608mm  
Safety area; 15m<sup>2</sup> | Free area: 3988x3988mm  
Age range: 2-8 years old  
Number of users: 4

## TECHNICAL FEATURES

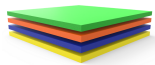

### BRAGPO

BragPO HDPE of high density in one color or bicolor, free of HPA. Characterized by its extreme lightness and elasticity, resistance to chemicals, corrosion, UV rays (UNE EN ISO 4892), to flammability (UNE-EN ISO 11925-2) and impact (ISO 527-1). It doesn't need any maintenance.  
Guarantee: 15 years.

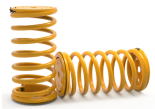

### SPRING

Helical spring in 35 SCD steel, with zinc phosphating and UV resistant lacquer, controlled in a magnetoscope field.



### STEEL ELECTROPLATED HARDWARE

Steel electroplated hardware, protected by polypropylene PP capsules.



### FIXATION SYSTEM

Type Y - Fixation system composed of built-in metal base or plumbing applied directly to the ground and concrete sinker.  
The built-in metal base is made of carbon steel sheet, with corrosion-resistant hot-dip galvanisation treatment of between 120 and 140µm thickness according to EN ISO 1461, which allows its placement without the plumb in direct contact with the ground. Its attachment to the plumb line is made by a quick clamping system increasing the longevity of the plumb line and its easy and fast replacement in case of need.





## PLAY FUNCTIONS



### FUN

While having fun, children acquire immense abilities, from physical abilities to social interactions.



### SOCIALIZING

Socialization and imagination are necessary throughout the game. All this creates a relationship between children and awakens the sense of coexistence and solidarity.



### VISUAL STIMULATION

It's through visual stimulation that children acquire essential stimuli that will boost the development of their visual field. Thus, it's essential that they develop a functional vision that allows them to play, socialize to internalize information from their surroundings and develop skills.



### TACTILE STIMULATION

It's through the act of play that it's possible to stimulate the tactile system in an easy and simple way, the introduction of objects with different textures allows children to start using their hands and thus awaken their tactile sensory perception.



### COGNITIVE DEVELOPMENT

An important aspect of play is the development of reasoning, imagination and attention. New games are essential to stimulate the ability to think, understand and act, developing the cognitive system.



### SWING

This movement develops the nervous system, especially at the psychomotor and vision level. In addition to being tranquilizer, it also develops the skills of balance and coordination.

## STANDARTS



### EN 1176-1

Playground equipment and surfacing  
Part 1: General safety requirements and test methods



### EN 1176-6

Playground equipment and surfacing  
Part 6: Additional specific safety requirements and test methods for rocking equipment

## CONFIDENTIALITY AND INTELLECTUAL PROPERTY

The information contained in this document is confidential, and the recipient cannot reproduce it or allow third parties to obtain, use or disclose it without the prior and express authorization of BRAGMAIA.

All intellectual property rights over the designs and models presented are the exclusive property of BRAGMAIA, and the practice of any act of exploitation thereof without the consent of the latter, under the terms of the industrial property code and the copyright code and related rights. Violation of BRAGMAIA's obligation of confidentiality and / or intellectual property rights may give rise to civil and criminal liability.





## DESCRIPTION

Équipement BragPLAY, Spring « quadruple » (FFH-0,60m), composé de 1 siège quadruple en contreplaqué marin antidérapant marron avec 4 tubes fixes en acier inoxydable pour arrondir le panneau BragPO avec 4 ouvertures pour créer de multiples supports de mains. Un ressort spiral 20x180x400mm en jaune.

Quincaillerie en acier électro-zingué.

Fixation au sol type Y (plomb).

Mesures générales (LxlxH): 988x988x608mm

Zone de sécurité; 15m<sup>2</sup> | Zone libre: 3988x3988mm

Tranche d'âge: 2-8 ans

Nombre d'utilisateurs: 4

## CARACTÉRISTIQUES TECHNIQUES

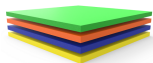

### BRAGPO

BragPO HDPE d'une couleur ou bicolore de haute densité, sans HPA. Caractérisé par son extrême légèreté et élasticité, résistante aux produits chimiques, à la corrosion, aux rayons UV (UNE EN ISO 4892), à l'inflammabilité (UNE-EN ISO 11925-2) et aux impacts (ISO 527-1). Pas d'entretien nécessaire.

Garantie: 15 ans.

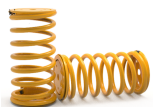

### RESSORT

Ressort hélicoïdal en acier 35 SCD, avec phosphatation de zinc et vernis résistant aux UV, contrôlé dans un champ de magnétoscope.



### FERRURES EN ACIER ELECTROZINGÉ

Ferrures en acier electrozingué, protégé para des capsules en polypropylène PP.



### SISTÈME DE FIXATION

Type Y - Système de fixation composé d'une base métallique encastrée ou d'une poutre appliquée directement au sol et bétonnée.

La base métallique encastrée est fabriquée en tôle d'acier carbone, avec un traitement anticorrosion par galvanisation par immersion à chaud d'une épaisseur comprise entre 120 et 140µm selon la norme EN ISO 1461, qui permet sa pose sans que la poutre rentre en contact direct avec le sol. Sa fixation à la poutre est réalisée par un système de serrage rapide augmentant sa longévité et facilitant son remplacement, qui sera rapide en cas de besoin.



## FONCTIONS DE JEU



### AMUSEMENT

En s'amusant, les enfants développent plusieurs capacités telles que des habilités physiques, émotionnelles, sociales et motrices.



### SOCIALES

L'importance de jouer se note dans l'interaction sociale que nécessitent ces activités, réveillant en eux le sens de la convivialité et de la solidarité. En jouant, les enfants apprennent à partager, respecter, et écouter autrui. De cette manière, ils débutent leur apprentissage en vie de société.



### STIMULATION VISUELLE

C'est au travers de cette action que les enfants vont comprendre le fonctionnement de plusieurs activités, c'est pour cela qu'il est important qu'ils développent leur perception visuelle et leur champ de vision. Grâce à ses capacités, ils pourront assimiler plus facilement des informations qui les entourent et développer plus facilement certaines capacités.



### STIMULATION TACTILE

Certains jeux sont tactiles. En effet, en faisant appel à différentes formes et matières pour lesquelles l'enfant utilise ses mains afin de trouver une solution.



### DÉVELOPPEMENT COGNITIF

Un aspect important lors de la diversion des enfants, c'est le développement de leurs sens, imagination et attention. De nouveaux jeux sont essentiels pour stimuler leurs capacités à penser, comprendre et agir.



### VACILLER

Ce mouvement appelle le système nerveux à entrer en jeu. En effet, les enfants auront besoin de le solliciter afin de tenir en équilibre. En plus d'être tranquilisant, il aide au développement de la coordination.

## NORMES



### EN 1176-1

Équipements et sols d'aires de jeux  
Partie 1: Exigences de sécurité et méthodes d'essai générales



### EN 1176-6

Équipements et sols d'aires de jeux  
Partie 6: Exigences de sécurité et méthodes d'essai complémentaires spécifiques aux équipements oscillants

## CONFIDENTIALITÉ ET PROPRIÉTÉ INTELLECTUELLE

Les informations contenues dans ce document sont confidentielles et le destinataire ne peut pas les reproduire ni permettre à des tiers de les obtenir, de les utiliser ou de les divulguer sans l'autorisation préalable et expresse de BRAGMAIA.

Tous les droits de propriété intellectuelle sur les dessins et modèles présentés sont propriété exclusive de BRAGMAIA, et la pratique d'un acte d'exploitation de ceux-ci sans le consentement de cette dernière, selon les termes du code de la propriété industrielle et du code du droit d'auteur et des droits voisins. La violation de l'obligation de confidentialité et / ou des droits de propriété intellectuelle de BRAGMAIA peut engager à la responsabilité civile et pénale.

