



13,50 m<sup>2</sup>



0,45 m



2-8



1



PORTUGAL  
[www.bragmaia.com](http://www.bragmaia.com)  
[geral@bragmaia.com](mailto:geral@bragmaia.com)  
Tlf. (+351) 273 302 440

**MEDIDAS GERAIS / MEDIDAS GENERALES / GENERAL MEASURES / MESURES GÉNÉRALES**

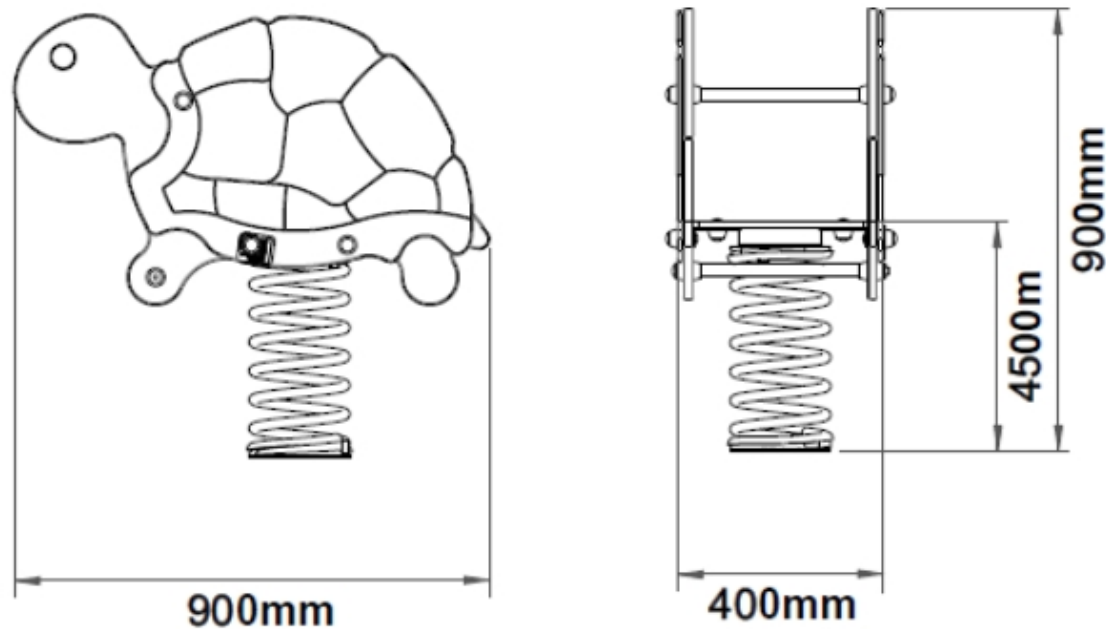

**INSTALAÇÃO / INSTALACIÓN / INSTALLATION / INSTALLATION**



0,15m<sup>3</sup>



01:00h



1x



0,00kg



0,00kg



1

13,50m<sup>2</sup>



0,45m

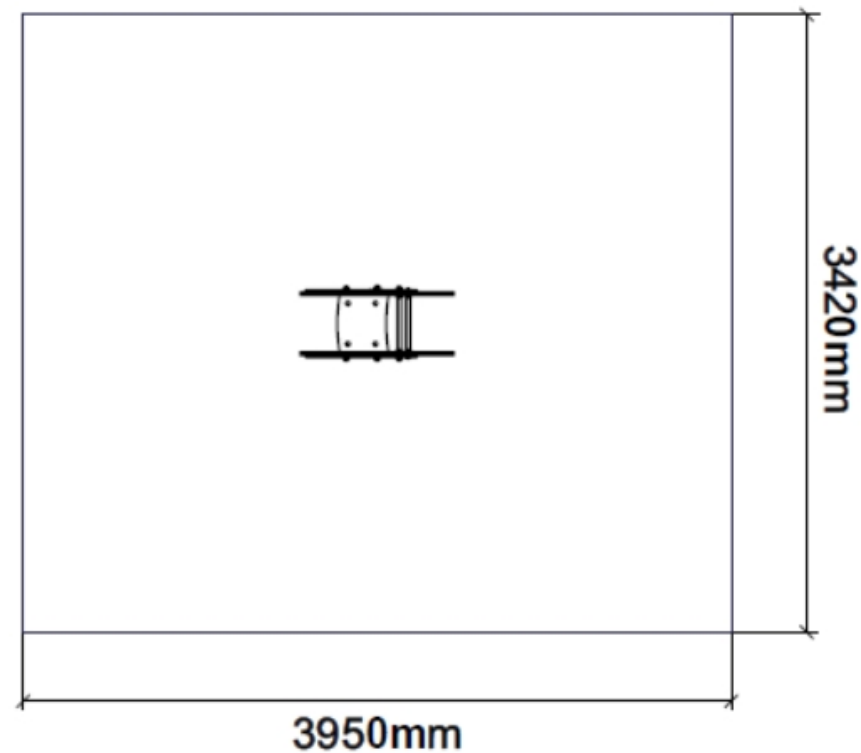

PORTUGAL  
www.bragmaia.com  
geral@bragmaia.com  
Tlf. (+351) 273 302 440

## DESCRIÇÃO

Equipamento BragPLAY, mola TARTARUGA (AQL 0.45m), composta por 1 assento, 2 painéis laterais em forma de tartaruga e painéis decorativos em forma de carapaça em Bragpo, 2 barras de apoio em tubo Ø25mm em aço inox, uma para as mãos e outra para os pés, 1 mola em espiral cor amarela. Ferragens em aço electrozincado. Fixação ao solo tipo Y (chumbar).



Medidas gerais (CxLxA): 900x400x900mm  
Área de segurança: 13.5m<sup>2</sup> | Área livre: 3950x3420mm  
Faixa etária: 2-8 anos  
Nº de utilizadores: 1

## CARACTERÍSTICAS TÉCNICAS



### BRAGPO

BragPO HDPE de alta densidade monocolor ou bicolor, livre de HPA. Caracterizado pela sua extrema leveza e elasticidade, resistência a produtos químicos, corrosão, raios UV (UNE EN ISO 4892), alta resistência à inflamabilidade (UNE-EN ISO 11925-2) e resistência a impactos (ISO 527-1). Não necessita de qualquer manutenção.  
Garantia: 15 anos

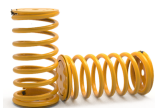

### MOLA

Mola helicoidal em aço 35 SCD, com fosfatização de zinco e lacagem cor amarela resistente a UV, controlada em campo magnetoscópio.



### FERRAGENS EM AÇO ELETROZINCADO

Ferragens em aço eletrozincado, protegidas por cápsulas em polipropileno PP.

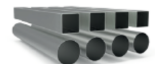

### TUBO AÇO INOX AISI 304

Tubo em aço inoxidável AISI 304, de acordo com a norma EN 14301, com acabamento 2B.  
Garantia: 15 anos.



PORTUGAL  
[www.bragmaia.com](http://www.bragmaia.com)  
[geral@bragmaia.com](mailto:geral@bragmaia.com)  
Tlf. (+351) 273 302 440



#### SISTEMA DE FIXAÇÃO

Tipo Y - Sistema de fixação composto por base metálica embutida ou por prumos aplicado diretamente no solo e chumbada com betão.

A base metálica embutida é fabricada em chapa de aço carbono, com tratamento anticorrosivo de galvanização por imersão a quente com espessura entre 120 a 140µm de acordo com a norma EN ISO 1461, que permite a sua colocação sem que o prumo entre em contacto direto com o solo. A sua fixação ao prumo é feita por um sistema de aperto rápido aumentando a longevidade do prumo e a sua fácil e rápida substituição em caso de necessidade.



## FUNÇÕES LÚDICAS



### DIVERSÃO

Enquanto se divertem, as crianças desenvolvem imensas capacidades, tais como: habilidades físicas, emocionais, sociais e motoras.



### SOCIALIZAR

A importância de brincar reside no facto das brincadeiras promoverem a interação social, despertando-lhes o senso de convivência e solidariedade. Enquanto brincam, as crianças aprendem a partilhar, respeitar e ouvir os outros, desta forma iniciam a sua preparação para viver em sociedade.



### JOGAR

O ato de jogar é muito mais do que uma mera brincadeira, trata-se de uma atividade, em que as crianças aliam a diversão, atividade física e interação social. É também nestes momentos, que estimulam a sua capacidade de trabalhar em equipa, algo essencial para o seu futuro pessoal, social e laboral. Ao jogar a criança desenvolve a paciência, a partilha, a concentração e o espírito desportivo.



### DESENVOLVIMENTO COGNITIVO

Um aspeto importante do ato de brincar, é o desenvolvimento do raciocínio, da sua imaginação e atenção. Novas brincadeiras são essenciais para estimular a capacidade de pensar, compreender e agir, desenvolvendo o sistema cognitivo.



### BALANÇAR

Este movimento proporciona o desenvolvimento do sistema nervoso, sobretudo ao nível psicomotor e da visão. Para além de ser tranquilizante, desenvolve ainda as capacidades de equilíbrio e coordenação.

## CONFIDENCIALIDADE E PROPRIEDADE INTELECTUAL

A informação contida neste documento é confidencial, não podendo o destinatário do mesmo reproduzi-la ou permitir a terceiros que a obtenham, utilizem ou divulguem sem a prévia e expressa autorização da BRICANTEL. Todos os direitos de propriedade intelectual sobre os desenhos e modelos apresentados são da titularidade exclusiva da BRICANTEL, sendo expressamente proibida a prática de qualquer ato de exploração dos mesmos sem o consentimento desta, nos termos do código da propriedade industrial e do código do direito de autor e dos direitos conexos. A violação da obrigação de confidencialidade e/ou dos direitos de propriedade intelectual da BRICANTEL, pode dar origem a responsabilidade civil e criminal.

## NORMAS



EN 1176-1

Equipamentos e superfícies para espaços de jogo e recreio  
Parte 1: Requisitos de segurança e métodos de ensaio gerais



PORTUGAL  
www.bragmaia.com  
geral@bragmaia.com  
Tlf. (+351) 273 302 440

## DESCRIPCIÓN

Equipamiento BragPLAY, muelle TARTARUGA (ACL0.45m), compuesto por 1 asiento y 2 paneles laterales en forma de tortuga, con paneles decorativos en forma de caparazón en bragpo. 2 barras de soporte en tubo Ø25mm en acero inoxidable, una para las manos y otra para los pies. 1 muelle en espiral color amarillo. Herrajes de acero electrochapado. Fijación al suelo tipo Y (hormigonado).



Medidas generales (LxAxA): 900x400x900mm  
Área de seguridad: 13.5m<sup>2</sup> | Área libre: 3950x3420mm  
Rango de edad: 2-8 años  
Número de usuarios: 1

## CARACTERÍSTICAS TÉCNICAS

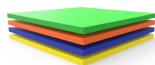

### BRAGPO

BragPO HDPE de alta densidad monocolor o bicolor, sin HPA. Caracterizado por su extrema ligereza y elasticidad, resistencia a productos químicos, corrosión, rayos UV (UNE EN ISO 4892), a la inflamabilidad (UNE-EN ISO 11925-2) y al impacto (ISO 527-1). No necesita ningún tipo de mantenimiento.  
Garantía: 15 años

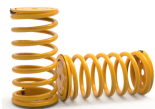

### MUELLE

Muelle helicoidal en acero 35 SCD, con fosfatado de zinc y lacado, resistente a los rayos UV, controlado en campo magnetoscopio.



### HERRAJES EN ACERO ELECTROCHAPADO

Herrajes en acero electrochapado, protegidos por cápsulas en polipropileno PP.



### TUBO ACERO INOX AISI 304

Tubo en acero inoxidable AISI 304, según la norma EN 14301, con refinamiento 2B.  
Garantía: 15 años.



PORTUGAL  
[www.bragmaia.com](http://www.bragmaia.com)  
[geral@bragmaia.com](mailto:geral@bragmaia.com)  
Tlf. (+351) 273 302 440



#### SISTEMA DE FIJACIÓN

Tipo Y - Sistema de fijación compuesto por una base metálica incorporada o hormigonado aplicado directamente al suelo y plomada con hormigón.

La base metálica incorporada está fabricada en chapa de acero carbono, con tratamiento anticorrosivo por inmersión en caliente de 120 a 140µm de espesor según EN ISO 1461, que permite su colocación sin que el poste entre en contacto directo con el suelo. Su fijación a al poste se realiza por un sistema de sujeción rápido aumentando la longevidad de la viga y su fácil y rápida sustitución en caso de necesidad.





## FUNCIONES DE JUEGO



### DIVERSIÓN

Mientras se divierten, los niños desarrollan una gran diversidad de capacidades, tales como: habilidades físicas, emocionales, sociales y motrices.



### SOCIALIZAR

La importancia del juego reside en que éste, promueve la interacción social, despertando en los niños la necesidad de convivencia y solidaridad. Mientras juegan, los niños aprenden a compartir, respetar y escuchar a los demás niños. Es la mejor forma de iniciar su preparación para convivir en sociedad.



### JUGAR

El simple acto de jugar es algo más que una mera diversión, se trata de una actividad en donde los niños aplican esa diversión a una actividad física, así como a interactuar socialmente. Es también en esta fase de su desarrollo, donde se estimula su capacidad de trabajar en equipo, algo primordialmente esencial para su desarrollo personal, social y laboral. Cuando juega, el niño desarrolla la paciencia, el compartir, la concentración y su espíritu deportivo.



### DESARROLLO COGNITIVO

Un aspecto importante del simple acto de jugar es el desarrollo del raciocinio, de su imaginación y atención. Son esenciales nuevas diversiones, a través del juego, para estimular la capacidad de pensar, comprender y reaccionar, desarrollando así, el sistema cognitivo.



### BALANCEARSE

Este movimiento proporciona el desarrollo del sistema nervioso, sobre todo a nivel psicomotor y de la visión. Además de ser tranquilizante, desarrolla todavía las capacidades de equilibrio y coordinación.

## CONFIDENCIALIDAD Y PROPIEDAD INTELECTUAL

La información contenida en este documento es estrictamente confidencial, no pudiendo el destinatario reproducirla o permitir a terceros que la adquieran, utilicen o divulguen sin la previa y expresa autorización de BRICANTEL.

Todos los derechos de propiedad intelectual sobre los diseños y modelos presentados son de titularidad exclusiva de BRICANTEL, estando expresamente prohibida la práctica de cualquier acto de usurpación de los mismos sin el previo consentimiento de la empresa, dentro de los términos del código de propiedad industrial y del código de derechos de autor y derechos análogos. La violación de la obligación de confidencialidad y/o de los derechos de propiedad intelectual de BRICANTEL, puede dar origen a responsabilidad civil y criminal.

## NORMAS



### EN 1176-1

Equipamiento de las áreas de juego y superficies

Parte 1: Requisitos generales de seguridad y métodos de ensayo.



PORTUGAL  
www.bragmaia.com  
geral@bragmaia.com  
Tlf. (+351) 273 302 440

## DESCRIPTION

BragPLAY Equipment, spring TARTARUGA (FFH:0.45m), composed of 1 seat and 2 side panels in the shape of a turtle in bragpo with decorative panels in the shape of a carapace, 2 support bars in stainless steel Ø25mm tube, one for the hands and one for the feet, 1 spring in spiral yellow. Type Y ground attachment (concreting).



General measures (LxWxH): 900x400x900mm  
Security area: 13.5m<sup>2</sup> | Free area: 3950x3420mm  
Age group: 2-8 years old  
Number of users: 1

## TECHNICAL FEATURES

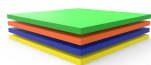

### BRAGPO

BragPO HDPE of high density in one color or bicolor, free of HPA. Characterized by its extreme lightness and elasticity, resistance to chemicals, corrosion, UV rays (UNE EN ISO4892), to flammability (UNE-EN ISO 11925-2) and impact (ISO 527-1). It doesn't need any maintenance.  
Guarantee: 15 years.

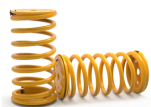

### SPRING

Helical spring in 35 SCD steel, with zinc phosphating and UV resistant lacquer, controlled in a magnetoscope field.



### STEEL ELECTROPLATED HARDWARE

Steel electroplated hardware, protected by polypropylene PP capsules.

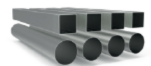

### STAINLESS STEEL TUBE AISI304

Tube in stainless steel AISI 304, according to EN 14301, with finish 2B.  
Guarantee: 15 years.



PORTUGAL  
[www.bragmaia.com](http://www.bragmaia.com)  
[geral@bragmaia.com](mailto:geral@bragmaia.com)  
Tlf. (+351) 273 302 440



**FIXATION SYSTEM**

Type Y - Fixation system composed of built-in metal base or plumbing applied directly to the ground and concrete sinker.

The built-in metal base is made of carbon steel sheet, with corrosion-resistant hot-dip galvanisation treatment of between 120 and 140µm thickness according to EN ISO 1461, which allows its placement without the plumb in direct contact with the ground. Its attachment to the plumb line is made by a quick clamping system increasing the longevity of the plumb line and its easy and fast replacement in case of need.



## PLAY FUNCTIONS



### FUN

While having fun, children acquire immense abilities, from physical abilities to social interactions.



### SOCIALIZING

Socialization and imagination are necessary throughout the game. All this creates a relationship between children and awakens the sense of coexistence and solidarity.



### PLAY

The act of playing is more than a diversion, it's an activity, in which children combine fun, physical activity and social interaction, It's also in these moments that they stimulate their ability to work as a team, something essential for their personal, social and working future. By playing the child develops patience, sharing, concentration and a sporting spirit.



### COGNITIVE DEVELOPMENT

An important aspect of play is the development of reasoning, imagination and attention. New games are essential to stimulate the ability to think, understand and act, developing the cognitive system.



### SWING

This movement develops the nervous system, especially at the psychomotor and vision level. In addition to being tranquilizer, it also develops the skills of balance and coordination.

## STANDARTS



### EN 1176-1

Playground equipment and surfacing

Part 1: General safety requirements and test methods

## CONFIDENTIALITY AND INTELLECTUAL PROPERTY

The information contained in this document is confidential, and the recipient cannot reproduce it or allow third parties to obtain, use or disclose it without the prior and express authorization of BRICANTEL.

All intellectual property rights over the designs and models presented are the exclusive property of BRICANTEL, and the practice of any act of exploitation thereof without the consent of the latter, under the terms of the industrial property code and the copyright code and related rights. Violation of BRICANTEL's obligation of confidentiality and / or intellectual property rights may give rise to civil and criminal liability.



PORTUGAL  
[www.bragmaia.com](http://www.bragmaia.com)  
[geral@bragmaia.com](mailto:geral@bragmaia.com)  
Tlf. (+351) 273 302 440

## DESCRIPTION

Equipement BragPLAY, ressort TARTARUGA (HCL0.45m), composé d'un siège et de 2 panneaux latéraux en forme de tortue, avec des panneaux décoratifs en forma de carapace en bragpo, 2 barres de support en tube Ø25mm en acier inoxydable, une pour les mains et une autre pour les pieds, 1 ressort spirale couleur jaune. Ferrures en acier électrozingué. Fixation au sol type Y (bétonner).



Mesures générales (LxLxH): 900x400x900mm  
Zone de sécurité: 13.5m<sup>2</sup> | Zone libre: 3950x3420mm  
Tranche d'âge: 2-8 ans  
Nombre d'utilisateurs: 1

## CARACTÉRISTIQUES TECHNIQUES

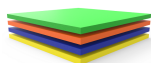

### BRAGPO

BragPO HDPE d'une couleur ou bicolore de haute densité, sans HPA. Caractérisé par son extrême légèreté et élasticité, résistante aux produits chimiques, à la corrosion, aux rayons UV (UNE EN ISO 4892), à l'inflammabilité (UNE-EN ISO 11925-2) et aux impacts (ISO 527-1). Pas d'entretien nécessaire.  
Garantie: 15 ans.

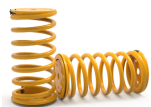

### RESSORT

Ressort hélicoïdal en acier 35 SCD, avec phosphatation de zinc et vernis résistant aux UV, contrôlé dans un champ de magnétoscope.



### FERRURES EN ACIER ELECTROZINGÉ

Ferrures en acier electrozingué, protégé para des capsules en polypropylène PP.



### TUBE EN ACIER INOXYDABLE AISI 304

Tube en acier inoxydable AISI 304, en accord avec la norme EN 14301, avec finition 2B.  
Garantie: 15 ans.



PORTUGAL  
[www.bragmaia.com](http://www.bragmaia.com)  
[geral@bragmaia.com](mailto:geral@bragmaia.com)  
Tlf. (+351) 273 302 440



#### SISTÈME DE FIXATION

Type Y - Système de fixation composé d'une base métallique encastrée ou d'une poutre appliquée directement au sol et bétonnée.

La base métallique encastrée est fabriquée en tôle d'acier carbone, avec un traitement anticorrosion par galvanisation par immersion à chaud d'une épaisseur comprise entre 120 et 140µm selon la norme EN ISO 1461, qui permet sa pose sans que la poutre rentre en contact direct avec le sol. Sa fixation à la poutre est réalisée par un système de serrage rapide augmentant sa longévité et facilitant son remplacement, qui sera rapide en cas de besoin.



## FONCTIONS DE JEU



### AMUSEMENT

En s'amusant, les enfants développent plusieurs capacités telles que des habilités physiques, émotionnelles, sociales et motrices.



### SOCIALES

L'importance de jouer se note dans l'interaction sociale que nécessitent ces activités, réveillant en eux le sens de la convivialité et de la solidarité. En jouant, les enfants apprennent à partager, respecter, et écouter autrui. De cette manière, ils débent leur apprentissage en vie de société.



### JOUER

Jouer n'est pas une simple plaisanterie, il s'agit d'une activité où les enfants peuvent allier diversion, activité physique et interaction sociale. C'est aussi dans ces moments qu'ils stimulent leur capacité à travailler en équipe, qualité essentielle pour sa vie future tant sur le plan personnelle, social et professionnelle. En jouant, l'enfant développe sa patience, sa concentration et son esprit de partage et sportif.



### DÉVELOPPEMENT COGNITIF

Un aspect importante lors de la diversion des enfants, c'est le développement de leurs sens, imagination et attention. De nouveaux jeux sont essentiels pour stimuler leurs capacités à penser, comprendre et agir.



### VACILLER

Ce mouvement appelle le système nerveux à entrer en jeu. En effet, les enfants auront besoin de le solliciter afin de tenir en équilibre. En plus d'être tranquilisant, il aide au développement de la coordination.

## CONFIDENTIALITÉ ET PROPRIÉTÉ INTELLECTUELLE

Les informations contenues dans ce document sont confidentielles et le destinataire ne peut pas les reproduire ni permettre à des tiers de les obtenir, de les utiliser ou de les divulguer sans l'autorisation préalable et expresse de BRICANTEL.

Tous les droits de propriété intellectuelle sur les dessins et modèles présentés sont propriété exclusive de BRICANTEL, et la pratique d'un acte d'exploitation de ceux-ci sans le consentement de cette dernière, selon les termes du code de la propriété industrielle et du code du droit d'auteur et des droits voisins. La violation de l'obligation de confidentialité et / ou des droits de propriété intellectuelle de BRICANTEL peut engager à la responsabilité civile et pénale.

## NORMES



EN 1176-1

Équipements et sols d'aires de jeux

Partie 1: Exigences de sécurité et méthodes d'essai générales



PORTUGAL  
www.bragmaia.com  
geral@bragmaia.com  
Tlf. (+351) 273 302 440