

Tolerância Geral: $\pm 5\%$



12,00 m²



0,45 m



2-8



1



MEDIDAS GERAIS / MEDIDAS GENERALES / GENERAL MEASURES / MESURES GÉNÉRALES

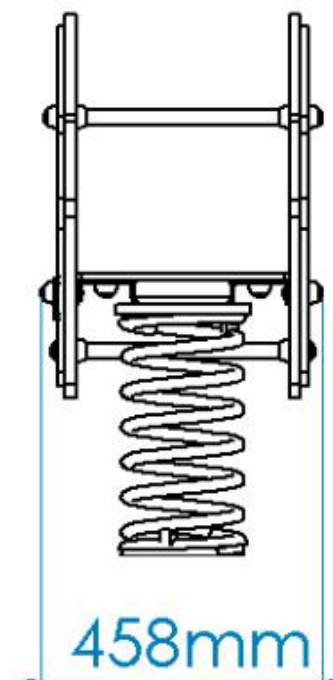
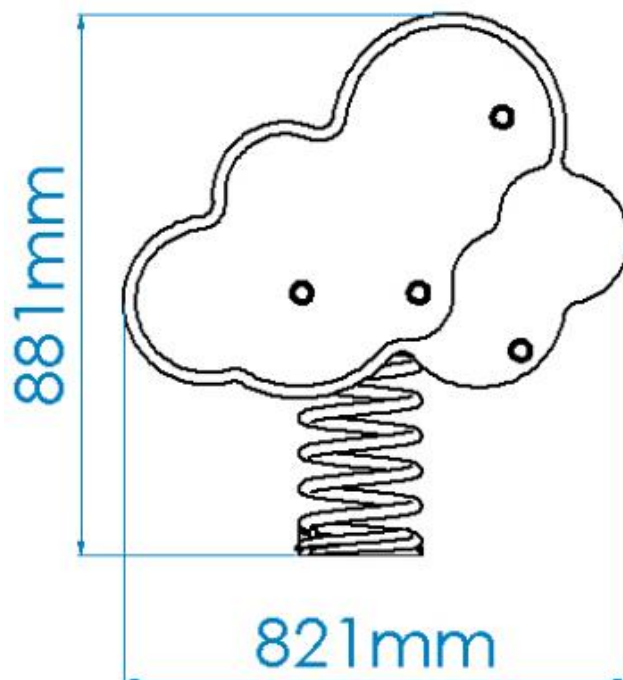

INSTALAÇÃO / INSTALACIÓN / INSTALLATION / INSTALLATION



0,09m³



00:30h



2x



31,00kg



31,00kg



1

12,00m²



0,45m

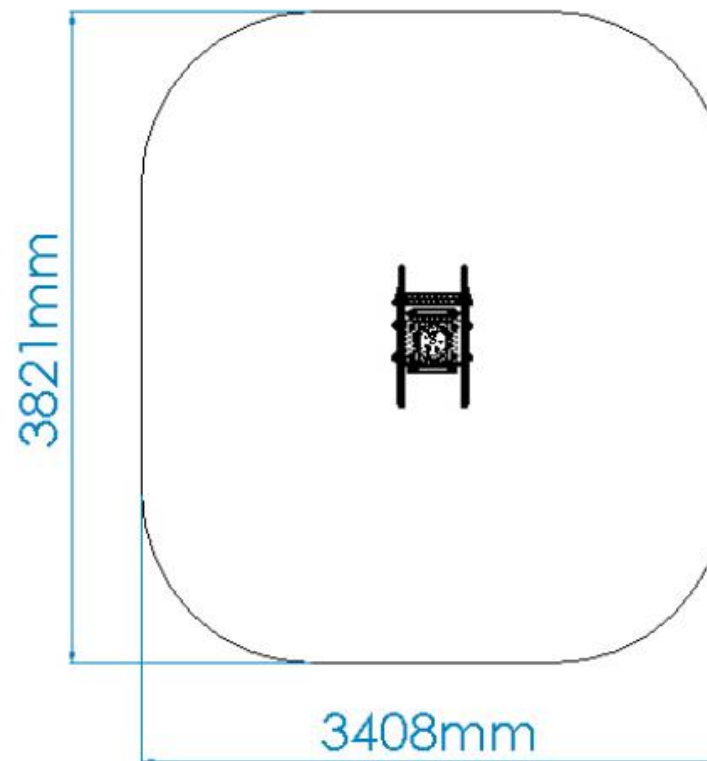



DESCRIÇÃO

Equipamento BragPLAY, mola Nuvem(AQL - 0.45m), composta por 1 assento, 2 painéis laterais em forma de "Nuvem" e painéis decorativos em forma de "Nuvem" em Bragpo, 2 barras de apoio em tubo Ø25mm em aço inox, uma para as mãos e outra para os pés, 1 mola em espiral 20x180x400mm cor amarela.

Ferragens em aço eletrozincado.

Fixação ao solo tipo X (aparafusar).

Medidas gerais (CxLxA): 821x458x881mm

Área de segurança: 12m² | Área livre: 3821x3408mm

Faixa etária: 2-8 anos

Nº de utilizadores: 1

CARACTERÍSTICAS TÉCNICAS

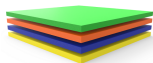

BRAGPO

BragPO HDPE de alta densidade monocolor ou bicolor, livre de HPA. Caracterizado pela sua extrema leveza e elasticidade, resistência a produtos químicos, corrosão, raios UV (UNE EN ISO 4892), alta resistência à inflamabilidade (UNE-EN ISO 11925-2) e resistência a impactos (ISO 527-1). Não necessita de qualquer manutenção.

Garantia: 15 anos

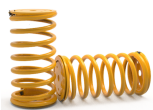

MOLA

Mola helicoidal em aço 35 SCD, com fosfatização de zinco e lacagem cor amarela resistente a UV, controlada em campo magnetoscópio.



MÃOZEIRAS/PEZEIRAS

Em tubo de aço inox AISI 304, acopladas com discos de BragPO e sistema de fixação protegido por cápsulas em polipropileno PP.



FERRAGENS EM AÇO ELETROZINCADO

Ferragens em aço eletrozincado, protegidas por cápsulas em polipropileno PP.



TUBO AÇO INOX AISI 304

Tubo em aço inoxidável AISI 304, de acordo com a norma EN 14301, com acabamento 2B.

Garantia: 15 anos.





SISTEMA DE FIXAÇÃO

Tipo X - Sistema de fixação composto por base metálica aparafusada ao solo rígido.

A base metálica é fabricada em chapa de aço carbono, com tratamento anticorrosivo de galvanização por imersão a quente com espessura entre 120 a 140µm de acordo com a norma EN ISO 1461, que permite a sua colocação sem que o prumo entre em contacto direto com o solo. A sua fixação ao prumo é feita por um sistema de aperto rápido aumentando a longevidade do prumo e a sua fácil e rápida substituição em caso de necessidade.

FUNÇÕES LÚDICAS



DIVERSÃO

Enquanto se divertem, as crianças desenvolvem imensas capacidades, tais como: habilidades físicas, emocionais, sociais e motoras.



SOCIALIZAR

A importância de brincar reside no facto das brincadeiras promoverem a interação social, despertando-lhes o senso de convivência e solidariedade. Enquanto brincam, as crianças aprendem a partilhar, respeitar e ouvir os outros, desta forma iniciam a sua preparação para viver em sociedade.



ESTIMULAÇÃO VISUAL

É através da estimulação visual, que as crianças adquirem estímulos essenciais que vão impulsionar o desenvolvimento do seu campo visual. Assim, é essencial que estas desenvolvam uma visão funcional, que as permita brincar, socializar para interiorizar informações do meio que as rodeia e desenvolver competências.



ESTIMULAÇÃO TÁTIL

É através do ato de brincar que se consegue estimular o sistema tátil de uma forma fácil e simples, a introdução de objetos com diferentes texturas permite que as crianças comecem a utilizar as mãos e desta forma, despertar a sua perceção sensorial tátil.



CRIATIVIDADE

São ações como inventar, sonhar, pensar e experimentar, que desenvolvem a criatividade das crianças. Dessa forma, estas passam a compreender e a usar as suas competências orais, motoras e cognitivas nas mais diversas atividades.



BALANÇAR

Este movimento proporciona o desenvolvimento do sistema nervoso, sobretudo ao nível psicomotor e da visão. Para além de ser tranquilizante, desenvolve ainda as capacidades de equilíbrio e coordenação.



NORMAS



EN 1176-1
Equipamentos e superfícies para espaços de jogo e recreio
Parte 1: Requisitos de segurança e métodos de ensaio gerais



EN 1176-6
Equipamentos e superfícies para espaços de jogo e recreio
Parte 6: Requisitos de segurança e métodos de ensaio adicionais, específicos para equipamentos oscilantes

CONFIDENCIALIDADE E PROPRIEDADE INTELECTUAL

A informação contida neste documento é confidencial, não podendo o destinatário do mesmo reproduzi-la ou permitir a terceiros que a obtenham, utilizem ou divulguem sem a prévia e expressa autorização da BRAGMAIA. Todos os direitos de propriedade intelectual sobre os desenhos e modelos apresentados são da titularidade exclusiva da BRAGMAIA, sendo expressamente proibida a prática de qualquer ato de exploração dos mesmos sem o consentimento desta, nos termos do código da propriedade industrial e do código do direito de autor e dos direitos conexos. A violação da obrigação de confidencialidade e/ou dos direitos de propriedade intelectual da BRAGMAIA, pode dar origem a responsabilidade civil e criminal.





DESCRIPCIÓN

Equipamiento BragPLAY Muelle "Nube" (HIC - 0.45m). Compuesto por 1 asiento, 2 paneles laterales decorativos en forma de "Nube" en Bragpo, 2 barras de apoyo en tubo de Ø25mm de acero Inox, una para las manos y otra para los pies, 1 muelle de 20x180x400mm color amarillo.

Herrajes de acero electrocincado.

Fijación al suelo Tipo X (atornillado).

Medidas generales (LxAnxA): 821x458x881mm

Área de seguridad: 12m² | Área libre: 3821x3408mm

Rango de edad: 2-8 años

Nº de usuarios: 1 niño

CARACTERÍSTICAS TÉCNICAS

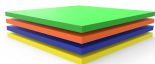

BRAGPO

BragPO HDPE de alta densidad monocolor o bicolor, sin HPA. Caracterizado por su extrema ligereza y elasticidad, resistencia a productos químicos, corrosión, rayos UV (UNE EN ISO 4892), a la inflamabilidad (UNE-EN ISO 11925-2) y al impacto (ISO 527-1). No necesita ningún tipo de mantenimiento.

Garantía: 15 años



MUELLE

Muelle helicoidal en acero 35 SCD, con fosfatado de zinc y lacado, resistente a los rayos UV, controlado en campo magnetoscopio.



ASIDEROS/REPOSAPIÉS

En tubo de acero inoxidable AISI 304, acoplado con discos de BragPO y sistema de fijación protegido por cápsulas de polipropileno PP.



HERRAJES EN ACERO ELECTROCHAPADO

Herrajes en acero electrochapado, protegidos por cápsulas en polipropileno PP.



TUBO ACERO INOX AISI 304

Tubo en acero inoxidable AISI 304, según la norma EN 14301, con refinamiento 2B.

Garantía: 15 años.





SISTEMA DE FIJACIÓN

Tipo X - Sistema de fijación compuesto por una base metálica y atornillada al suelo rígido.

La base metálica es fabricada en chapa de acero al carbono, con tratamiento anticorrosivo de galvanización por inmersión en caliente con espesor entre 120 y 140µm de acuerdo con la norma EN ISO 1461, que permite su colocación sin que la viga entre en contacto directo con el suelo. Su fijación a la viga es hecha por un sistema de sujeción rápido aumentando la longevidad de la viga y su fácil y rápida sustitución en caso de necesidad.

FUNCIONES DE JUEGO



DIVERSIÓN

Mientras se divierten, los niños desarrollan una gran diversidad de capacidades, tales como: habilidades físicas, emocionales, sociales y motrices.



SOCIALIZAR

La importancia del juego reside en que éste, promueve la interacción social, despertando en los niños la necesidad de convivencia y solidaridad. Mientras juegan, los niños aprenden a compartir, respetar y escuchar a los demás niños. Es la mejor forma de iniciar su preparación para convivir en sociedad.



ESTIMULACIÓN VISUAL

A través de la estimulación visual, los niños adquieren incentivos esenciales que van a aumentar el desarrollo de su campo visual. De esta manera, es primordial que ellos desarrollen una visión funcional que les permita jugar y socializar para interiorizar informaciones del medio que los rodea, así como a desarrollar capacidades.



ESTIMULACIÓN TÁCTIL

A través del acto del juego se consigue estimular el sentido táctil de una forma fácil y simple. La introducción de objetos con diferentes texturas permite que los niños comiencen a utilizar las manos, y de esta forma, se despierte su percepción sensorial táctil.



CREATIVIDAD

Se trata de acciones tales como inventar, soñar, pensar y percibir, que desarrollan la creatividad de los niños. De esta manera pasan a comprender y a usar sus competencias orales, motoras y cognitivas en las más diversas actividades.



BALANCEARSE

Este movimiento proporciona el desarrollo del sistema nervioso, sobre todo a nivel psicomotor y de la visión. Además de ser tranquilizante, desarrolla todavía las capacidades de equilibrio y coordinación.



NORMAS



EN 1176-1
Equipamiento de las áreas de juego y superficies
Parte 1: Requisitos generales de seguridad y métodos de ensayo.



EN 1176-6
Equipamiento de las áreas de juego y superficies
Parte 6: Requisitos de seguridad y métodos de ensayo adicionales específicos para balancines

CONFIDENCIALIDAD Y PROPIEDAD INTELECTUAL

La información contenida en este documento es estrictamente confidencial, no pudiendo el destinatario reproducirla o permitir a terceros que la adquieran, utilicen o divulguen sin la previa y expresa autorización de BRAGMAIA. Todos los derechos de propiedad intelectual sobre los diseños y modelos presentados son de titularidad exclusiva de BRAGMAIA, estando expresamente prohibida la práctica de cualquier acto de usurpación de los mismos sin el previo consentimiento de la empresa, dentro de los términos del código de propiedad industrial y del código de derechos de autor y derechos análogos. La violación de la obligación de confidencialidad y/o de los derechos de propiedad intelectual de BRAGMAIA, puede dar origen a responsabilidad civil y criminal.





DESCRIPTION

BragPLAY equipment, Cloud playground springer (FFH - 0.45m), comprising 1 seat, 2 side panels in the shape of a "Cloud" and decorative panels in the shape of a "Cloud" in Bragpo, 2 support bars in Ø25mm stainless steel tube, one for the hands and one for the feet, one 20x180x400mm spiral spring in yellow colour.

Electro-zinc-plated steel fittings.

X-type ground fixing (screw).

Dimensions (LxWxH): 821x458x881mm

Safety area: 12m² | Free area: 3821x3408mm

Age range: 2-8 years

Number of users: 1

TECHNICAL FEATURES

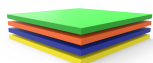

BRAGPO

BragPO HDPE of high density in one color or bicolor, free of HPA. Characterized by its extreme lightness and elasticity, resistance to chemicals, corrosion, UV rays (UNE EN ISO 4892), to flammability (UNE-EN ISO 11925-2) and impact (ISO 527-1). It doesn't need any maintenance.

Guarantee: 15 years.

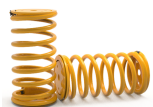

SPRING

Helical spring in 35 SCD steel, with zinc phosphating and UV resistant lacquer, controlled in a magnetoscope field.



HANDLES/FOOTRESTS

In AISI 304 stainless Steel tube, couples with BragPO discs and fixing system protected by PP polypropylene caps.



STEEL ELECTROPLATED HARDWARE

Steel electroplated hardware, protected by polypropylene PP capsules.



STAINLESS STEEL TUBE AISI 304

Tube in stainless steel AISI 304, according to EN 14301, with finish 2B.

Guarantee: 15 years.





FIXATION SYSTEM

Type X - Fixation system composed of a metal base bolted to the hard ground.

The metal base is made of carbon steel sheet, with corrosion-resistant hot-dip galvanisation treatment of between 120 and 140µm thickness according to EN ISO 1461, which allows its placement without the plumb in direct contact with the ground. Its attachment to the plumb line is made by a quick clamping system increasing the longevity of the plumb line and its easy and fast replacement in case of need.

PLAY FUNCTIONS



FUN

While having fun, children acquire immense abilities, from physical abilities to social interactions.



SOCIALIZING

Socialization and imagination are necessary throughout the game. All this creates a relationship between children and awakens the sense of coexistence and solidarity.



VISUAL STIMULATION

It's through visual stimulation that children acquire essential stimuli that will boost the development of their visual field. Thus, it's essential that they develop a functional vision that allows them to play, socialize to internalize information from their surroundings and develop skills.



TACTILE STIMULATION

It's through the act of play that it's possible to stimulate the tactile system in an easy and simple way, the introduction of objects with different textures allows children to start using their hands and thus awaken their tactile sensory perception.



CREATIVITY

These are actions such as inventing, dreaming, thinking and experimenting, which develop children's creativity. In this way, they begin to understand and use their oral, motor and cognitive skills in the most diverse activities.



SWING

This movement develops the nervous system, especially at the psychomotor and vision level. In addition to being tranquilizer, it also develops the skills of balance and coordination.



STANDARTS



EN 1176-1
Playground equipment and surfacing
Part 1: General safety requirements and test methods



EN 1176-6
Playground equipment and surfacing
Part 6: Additional specific safety requirements and test methods for rocking equipment

CONFIDENTIALITY AND INTELLECTUAL PROPERTY

The information contained in this document is confidential, and the recipient cannot reproduce it or allow third parties to obtain, use or disclose it without the prior and express authorization of BRAGMAIA.

All intellectual property rights over the designs and models presented are the exclusive property of BRAGMAIA, and the practice of any act of exploitation thereof without the consent of the latter, under the terms of the industrial property code and the copyright code and related rights. Violation of BRAGMAIA's obligation of confidentiality and / or intellectual property rights may give rise to civil and criminal liability.



PORTUGAL
www.bragmaia.com
geral@bragmaia.com

brag
PLAY

brag
URBAN

brag
SPORT

brag
SIGN

brag
LIGHT

Informação sujeita a alterações sem aviso prévio.

Data de exportação: 16/03/2024

DESCRIPTION

Équipement BragPLAY, jeu sur ressort Nuage (HCL - 0,45m), comprenant 1 siège, 2 panneaux latéraux en forme de "nuage" et panneaux décoratifs en forme de "nuage" en Bragpo, 2 barres d'appui en tube de Ø25mm en acier inoxydable, une pour les mains et une pour les pieds, 1 ressort hélicoïdal de 20x180x400mm de couleur jaune.

Visserie en acier électrozingué.
Fixation au sol de type X (visser).

Dimensions (Lxlxh): 821x458x881mm
Zone de sécurité: 12m2 | Zone libre: 3821x3408mm
Tranche d'âge: 2-8 ans
Nombre d'utilisateurs: 1

CARACTÉRISTIQUES TECHNIQUES

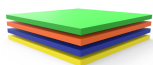

BRAGPO

BragPO HDPE d'une couleur ou bicolore de haute densité, sans HPA. Caractérisé par son extrême légèreté et élasticité, résistante aux produits chimiques, à la corrosion, aux rayons UV (UNE EN ISO 4892), à l'inflammabilité (UNE-EN ISO 11925-2) et aux impacts (ISO 527-1). Pas d'entretien nécessaire.
Garantie: 15 ans.

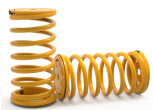

RESSORT

Ressort hélicoïdal en acier 35 SCD, avec phosphatation de zinc et vernis résistant aux UV, contrôlé dans un champ de magnétoscope.



POIGNÉES/CALE-PIEDS

En tube d'acier inoxydable AISI 304, couplé avec des disques BragPO et un système de fixation protégé par des bouchons en polypropylène PP.



FERRURES EN ACIER ELECTROZINGÉ

Ferrures en acier électrozingué, protégé para des capsules en polypropylène PP.



TUBE EN ACIER INOXYDABLE AISI 304

Tube en acier inoxydable AISI 304, en accord avec la norme EN 14301, avec finition 2B.
Garantie: 15 ans.





SISTÈME DE FIXATION

Type X - Système de fixation composé d'une base métallique fixée au sol rigide.

La base métallique est fabriquée en tôle d'acier carbone, avec un traitement anticorrosion par galvanisation par immersion à chaud d'une épaisseur comprise entre 120 et 140µm selon la norme EN ISO 1461, qui permet sa pose sans que la poutre rentre en contact direct avec le sol. Sa fixation à la poutre est réalisée par un système de serrage rapide augmentant sa longévité et facilitant son remplacement, qui sera rapide en cas de besoin.

FONCTIONS DE JEU



AMUSEMENT

En s'amusant, les enfants développent plusieurs capacités telles que des habilités physiques, émotionnelles, sociales et motrices.



SOCIALES

L'importance de jouer se note dans l'interaction sociale que nécessitent ces activités, réveillant en eux le sens de la convivialité et de la solidarité. En jouant, les enfants apprennent à partager, respecter, et écouter autrui. De cette manière, ils débentent leur apprentissage en vie de société.



STIMULATION VISUELLE

C'est au travers de cette action que les enfants vont comprendre le fonctionnement de plusieurs activités, c'est pour cela qu'il est important qu'ils développent leur perception visuelle et leur champ de vision. Grâce à ses capacités, ils pourront assimiler plus facilement des informations qui les entourent et développer plus facilement certaines capacités.



STIMULATION TACTILE

Certains jeux sont tactiles. En effet, en faisant appel à différentes formes et matières pour lesquelles l'enfant utilise ses mains afin de trouver une solution.



CRÉATIVITÉ

Rêver, inventer, penser et essayer, se sont là des actes qui aident les enfants à développer leur créativité. De cette manière, ces derniers comprennent comment utiliser leur compétence orale, motrice et cognitive dans de diverses situations.



VACILLER

Ce mouvement appelle le système nerveux à entrer en jeu. En effet, les enfants auront besoin de le solliciter afin de tenir en équilibre. En plus d'être tranquilisant, il aide au développement de la coordination.



NORMES



EN 1176-1
Équipements et sols d'aires de jeux
Partie 1: Exigences de sécurité et méthodes d'essai générales



EN 1176-6
Équipements et sols d'aires de jeux
Partie 6: Exigences de sécurité et méthodes d'essai complémentaires spécifiques aux équipements oscillants

CONFIDENTIALITÉ ET PROPRIÉTÉ INTELLECTUELLE

Les informations contenues dans ce document sont confidentielles et le destinataire ne peut pas les reproduire ni permettre à des tiers de les obtenir, de les utiliser ou de les divulguer sans l'autorisation préalable et expresse de BRAGMAIA.
Tous les droits de propriété intellectuelle sur les dessins et modèles présentés sont propriété exclusive de BRAGMAIA, et la pratique d'un acte d'exploitation de ceux-ci sans le consentement de cette dernière, selon les termes du code de la propriété industrielle et du code du droit d'auteur et des droits voisins. La violation de l'obligation de confidentialité et / ou des droits de propriété intellectuelle de BRAGMAIA peut engager à la responsabilité civile et pénale.

