

ARIANNE

ELUNI026

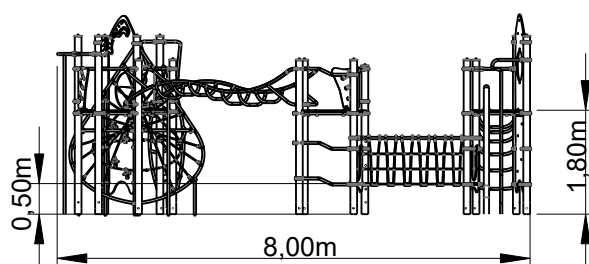

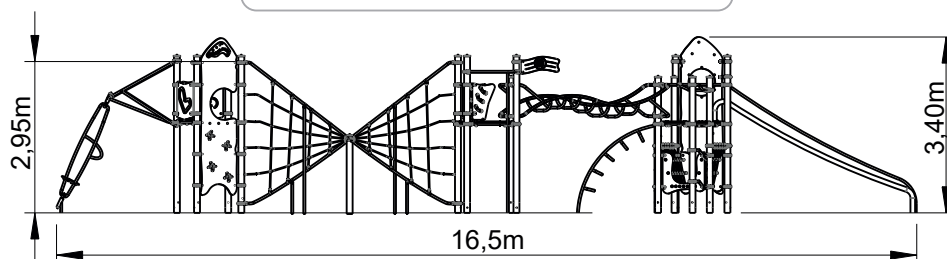
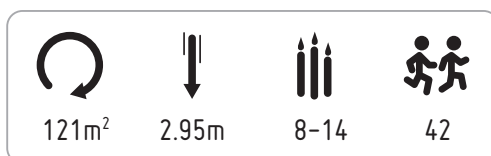

Utilização do equipamento sujeito a condições vigiadas; Zona de segurança: Área mínima requerida pela norma EN 1176-1,6
 Utilización del equipo sujeto a condiciones vigiladas; Zona de seguridad: Área mínima requerida por la norma EN 1176-1,6
 Use of equipment subject to supervised conditions; Safety zone: Minimum area required by EN 1176-1,6
 Utilisation d'équipement soumis à des conditions supervisées; Zone de sécurité: Surface minimale requise par l'EN 1176-1,6



— Zona de impacto
 - - Espaço livre

EN 1176-1,3



.....	1	2
	1.80	2.95
	92	29
m²	121	

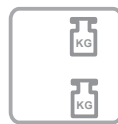
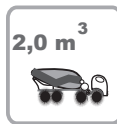
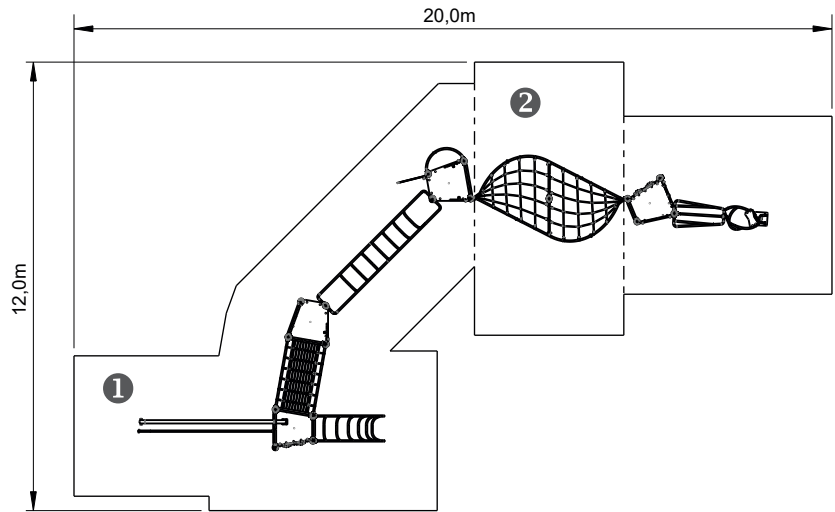

INFORMAÇÃO TÉCNICA / INFORMACIÓN TÉCNICA / TECHNICAL INFORMATION / INFORMATIONS TECHNIQUES

- 1 - Torre Luna  1.80m
- 2 - Torre Espacial  1.80m
- 3 - Escadote Ariane  1.80m
- 4 - Escadote  1.80m
- 5 - Parede Escalada Luna  1.80m
- 6 - Ponte Espacial  0.50m
- 7 - Tobógan Turbo  1.80m
- 8 - Varão Bombeiro  1.80m
- 9 - Rede 3D  2.95m
- 10 - Travessia Aérea  2.00m
- 11 - Giróstato  0.50m
- 12 - Parede Escalada Espacial  1.80m

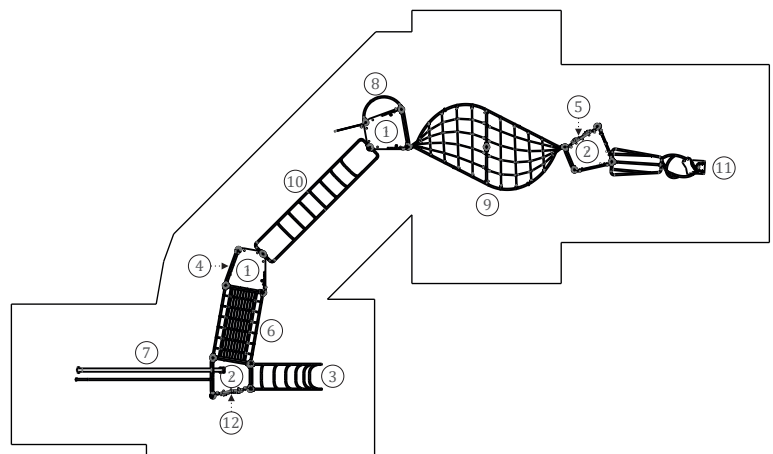



Painéis

HDPE: Polietileno de alta densidade monocolor ou bicolor. Por ser um polímero é caracterizado pela sua resistência a produtos químicos e à corrosão. Pela sua capacidade de elasticidade e leveza, oferece alta resistência ao impacto, sendo muito difícil quebrar. A superfície antiderrapante fornece segurança para as crianças e a sua base sintética impede o cultivo de bactérias e fungos. Não necessita de qualquer manutenção;

Acrílico

composto de 70% de fibras de coníferas e 30% de resina termofixa, resistente às intempéries (sol, chuva, humidade, etc.);

Rede

cordas Ø16mm reforçadas em aço revestido por fibras de polipropileno, acessórios de ligação e fixação em plástico HDPE com protecção U.V., elementos de fixação em aço galvanizado a quente;

Peças Metálicas

Tubos: Aço Inox AISI 304 de Ø40mm e de Ø114mm;

Sistema de fixação

Tipo C – Standard composto por prumo aplicado directamente no solo e chumbado com betão;

Parafusos e acessórios

Parafusos: Aço zincado ou opcionalmente aço inox AISI 304;

Câpsulas: Plástico polipropileno PP;

100%

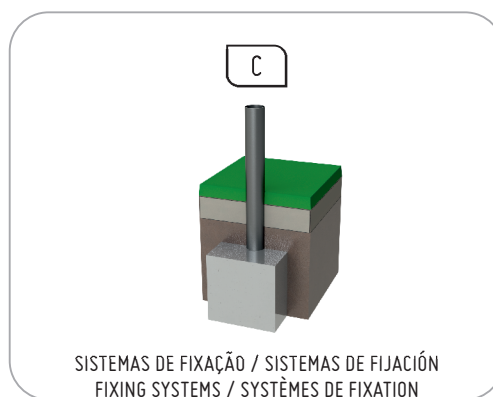



FUNÇÕES LÚDICAS / FUNCIONES LÚDICAS / RECREATIONAL FUNCTIONS / FONCTIONS RÉCRÉATIVES



Divertir: Enquanto se divertem, as crianças adquirem imensas capacidades, desde habilidades físicas a interações sociais.



Socializar: A socialização e a imaginação são necessárias em todo o jogo. Tudo isso cria relação entre crianças e desperta o senso de convivência e a solidariedade.



Jogar: Desenvolve a paciência, a partilha e o espírito desportivo.



Trepar: Desenvolve as capacidades motrizes das crianças, o controlo do próprio corpo, o equilíbrio e a coordenação, estimulando a capacidade motora e a força nos movimentos.



Deslizar: Esta actividade proporciona uma sensação fascinante que por sua vez ajuda a desenvolver o equilíbrio e a coordenação estimulando o sistema nervoso.



paneles

HDPE: Polietileno de alta densidad monocolor o bicolor. Por ser un polímero se caracteriza por su resistencia a los productos químicos y a la corrosión. Por su capacidad de elasticidad y ligereza, ofrece alta resistencia al impacto, siendo muy difícil romper. La superficie antideslizante proporciona seguridad para los niños y su base sintética impide el cultivo de bacterias y hongos. No necesita mantenimiento;

acrílico

compuesto de 70% de fibras de coníferas y 30% de resina termofijo, resistente a la intemperie (sol, lluvia, humedad, etc.);

red

cuerdas Ø16mm reforzadas en acero revestido por fibras de polipropileno, accesorios de conexión y fijación de plástico HDPE con protección U.V., elementos de fijación en acero galvanizado en caliente;

Piezas Metálicas

Tubos: Acero Inox AISI 304 de Ø40mm y de Ø114mm;

Sistema de fijación

Tipo C – Standard compuesto por pluma aplicada directamente en el suelo y plomado con hormigón;

Tornillos y accesorios

Tornillos: Acero zincado o opcionalmente acero inoxidable AISI 304;

Cápsulas: Plástico polipropileno PP;

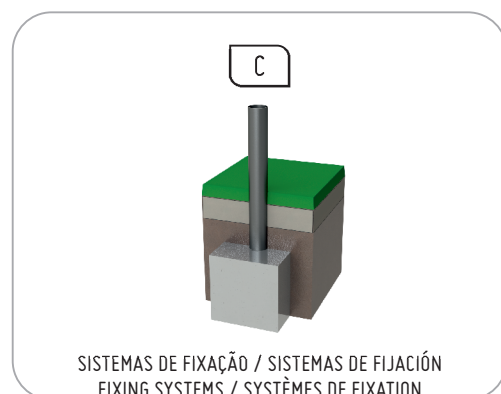



Divertir: Mientras se divierten, los niños adquieren inmensas capacidades, desde habilidades físicas a interacciones sociales.



Socializar: La socialización y la imaginación son necesarias en todo el juego. Todo esto crea relación entre niños y despierta el sentido de convivencia y la solidaridad.



Jugar: Desarrolla la paciencia, el compartir y el espíritu deportivo.



Trepar: Desarrolla las capacidades motrices de los niños, el control del propio cuerpo, el equilibrio y la coordinación, estimulando la capacidad motora y la fuerza en los movimientos.



Deslizar: Esta actividad proporciona una sensación fascinante que a su vez ayuda a desarrollar el equilibrio y la coordinación estimulando el sistema nervioso.



Panels

HDPE: High density polyethylene mono or two color. Being a polymer is characterized by its resistance to chemicals and corrosion. Due to its elasticity and lightness, it offers high impact resistance and is very difficult to break. The non-slip surface provides safety for children and its synthetic base prevents the growth of bacteria and fungi. It does not require any maintenance;

Acrylic

composed of 70% coniferous fibers and 30% thermosetting resin, weather resistant (sun, rain, humidity, etc.);

Net

ropes Ø16mm reinforced in steel covered by polypropylene fibers, fittings and connection in HDPE plastic with U.V. protection, fastening elements in hot galvanized steel;

Metal parts

Tubes: Stainless steel AISI 304 of Ø40mm and Ø114mm;

Fixation System

Type C – Standard composed of plumbing applied directly to the ground and cast with concrete;

Screws and accessories

Screws: Zinc-plated steel or optionally AISI 304 stainless steel;

Capsules: PP polypropylene plastic;

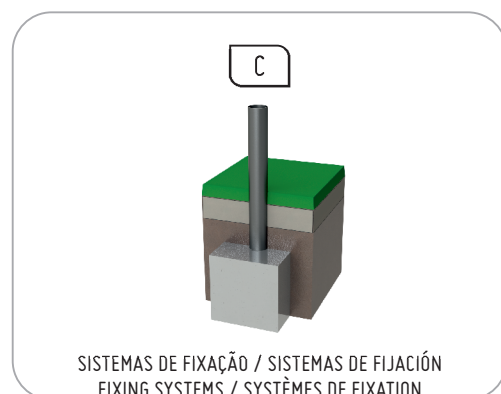



Fun: While having fun, children acquire immense abilities, from physical abilities to social interactions.



Socializing: Socialization and imagination are necessary throughout the game. All this creates a relationship between children and awakens the sense of coexistence and solidarity.



Play: Develops patience, sharing and sporting spirit.



Climb: It develops children's motor skills, body control, balance and coordination, stimulating motor ability and strength in movements.



Glide: This activity provides a fascinating feeling which in turn helps to develop balance and coordination by stimulating the nervous system.



Panneaux

HDPE: Polyéthylène haute densité mono ou bicolore. Être un polymère se caractérise par sa résistance aux produits chimiques et à la corrosion. Grâce à son élasticité et à sa légèreté, il offre une grande résistance aux chocs et est très difficile à briser. La surface antidérapante assure la sécurité des enfants et sa base synthétique empêche la croissance des bactéries et des champignons. Il ne nécessite aucun entretien

Acrylique

composé de 70% de fibres de conifères et de 30% de résine thermodurcissable, résistant aux intempéries (soleil, pluie, humidité, etc.);

Filet

cordes Ø16mm renforcées en acier recouvertes de fibres de polypropylène, raccords et raccords en plastique HDPE avec protection anti-UV, éléments de fixation en acier galvanisé à chaud;

Pièces métalliques

Tubes: acier inoxydable AISI 304 de Ø40mm et Ø114mm;

Système de fixation

Type C – Norme composée de plomberie appliquée directement sur le sol et coulée avec du béton;

Vis et accessoires

Vis: Acier zingué ou acier inoxydable AISI 304 en option;

Capsules: PP polypropylène plastique;

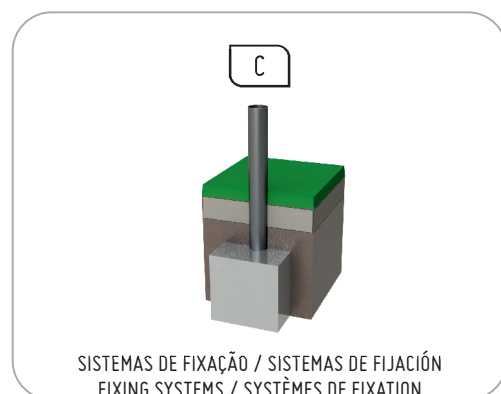



Amusement: tout en s'amusant, les enfants acquièrent d'énormes capacités, allant des capacités physiques aux interactions sociales.



Socialiser: la socialisation et l'imagination sont nécessaires tout au long du jeu. Tout cela crée une relation entre les enfants et éveille le sentiment de coexistence et de solidarité.



Jouer: Développe la patience, le partage et l'esprit sportif.



Escalade: Il développe les capacités motrices, le contrôle du corps, l'équilibre et la coordination des enfants, stimulant la capacité motrice et la force dans les mouvements.



Glide: Cette activité procure une sensation fascinante qui aide à développer l'équilibre et la coordination en stimulant le système nerveux.