



16,00 m<sup>2</sup>



0,00 m



12-99



3



PORTUGAL  
[www.bragmaia.com](http://www.bragmaia.com)  
[geral@bragmaia.com](mailto:geral@bragmaia.com)  
Tlf. (+351) 273 302 440

brag  
PLAY

brag  
URBAN

brag  
SPORT



PORTUGAL  
[www.bragmaia.com](http://www.bragmaia.com)  
[geral@bragmaia.com](mailto:geral@bragmaia.com)  
Tlf. (+351) 273 302 440

**brag**  
*PLAY*

**brag**  
*URBAN*

**brag**  
*SPORT*

**MEDIDAS GERAIS / MEDIDAS GENERALES / GENERAL MEASURES / MESURES GÉNÉRALES**

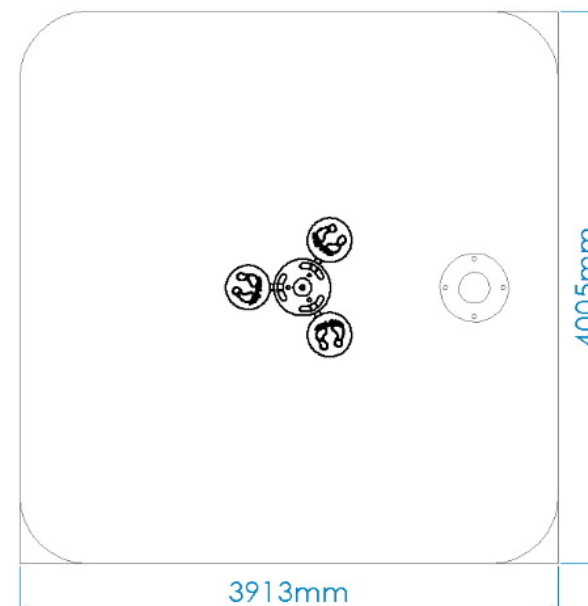
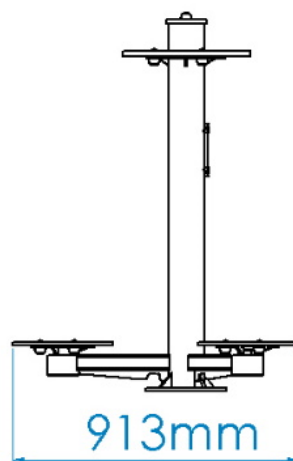
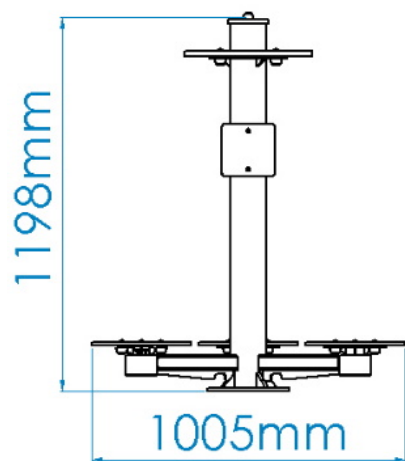

0,00m<sup>3</sup>



01:00h



2x



0,00kg



0,00kg



PORTUGAL  
www.bragmaia.com  
geral@bragmaia.com  
Tlf. (+351) 273 302 440

brag  
PLAY

brag  
URBAN

brag  
SPORT



PORTUGAL  
[www.bragmaia.com](http://www.bragmaia.com)  
[geral@bragmaia.com](mailto:geral@bragmaia.com)  
Tlf. (+351) 273 302 440

**brag**  
*PLAY*

**brag**  
*URBAN*

**brag**  
*SPORT*

## DESCRIÇÃO

Equipamento BragSPORT, biosaudável CINTURA TRIPLO, para exercitar a musculatura da cintura pélvica, da zona abdominal e lombar. Composto por estrutura em tubo central estrutural Ø114,3x3mm e restantes em tubos de Ø101,60x3mm, 50x50x3mm e chapa em aço inox 316. Painéis Bragpo azul e placa de instruções em PVC com impressão digital e laminação. Rolamentos esféricos em aço eletrozincado e ferragens em aço inox. Fixação ao solo apoio X (aparafusar). Com opção adicional de apoio Y (chumbar).



Medidas gerais (CxLxA): 913x1005x1198mm  
Área de segurança: 16m<sup>2</sup> | Área livre: 3913x4005mm  
Faixa etária: +12 anos  
Nº de utilizadores: 3

## CARACTERÍSTICAS TÉCNICAS

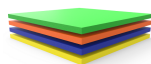

### BRAGPO

BragPO HDPE de alta densidade monocolor ou bicolor, livre de HPA. Caracterizado pela sua extrema leveza e elasticidade, resistência a produtos químicos, corrosão, raios UV (UNE EN ISO 4892), alta resistência à inflamabilidade (UNE-EN ISO 11925-2) e resistência a impactos (ISO 527-1). Não necessita de qualquer manutenção.  
Garantia: 15 anos



### ROLAMENTO ESFÉRICO

Rolamentos esféricos rígidos de uma carreira de esferas tampados com vedação em borracha para o fechamento, de acordo com a norma DIN 925-1.



### FERRAGENS EM AÇO INOX

Ferragens em aço inox, de acordo com a norma NF EN 10088, protegidas por cápsulas em polipropileno PP.



### TUBO AÇO INOX AISI 316

Tubo em aço inoxidável AISI 316, de acordo com a norma EN 14401, com acabamento 2B.  
Garantia: 15 anos



PORTUGAL  
[www.bragmaia.com](http://www.bragmaia.com)  
[geral@bragmaia.com](mailto:geral@bragmaia.com)  
Tlf. (+351) 273 302 440



PORTUGAL  
[www.bragmaia.com](http://www.bragmaia.com)  
[geral@bragmaia.com](mailto:geral@bragmaia.com)  
Tlf. (+351) 273 302 440

**brag**  
*PLAY*

**brag**  
*URBAN*

**brag**  
*SPORT*

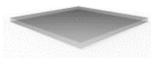

**CHAPA EM AÇO INOX AISI 316**

Chapa de aço lisa (EN 10327) de aço laminado a quente (EN 10027-1 e CR 10260), em aço inoxidável AISI 316, de acordo com a norma EN 14401, com acabamento 2B.



**PLACA GERIÁTRICO**

Fabricada em chapa de PVC rígido com 170x170x10mm, de moldagem simples, com alta resistência a produtos químicos, resistente aos impacto, auto extingüível (Classe M1), excelente isolamento elétrico e térmico e não é tóxico. Impressão digital em várias cores sobre vinil com acabamento laminado, com proteção UV e anti grafiti.



**SISTEMA DE FIXAÇÃO**

Tipo X - Sistema de fixação standart, composto por base metálica aparafusada ao solo rígido.

Tipo Y - Opcional, composto por apoio metálico embutido no solo e chumbada com betão.

O apoio metálico é fabricado em tubo Ø114mm e chapa de aço carbono, com tratamento anticorrosivo de galvanização por imersão a quente com espessura entre 120 a 140µm de acordo com a norma EN ISO 1461, que permite a sua colocação sem que o prumo entre em contacto direto com o solo. A sua fixação ao prumo é feita por um sistema de aperto rápido aumentando a longevidade do prumo e a sua fácil e rápida substituição em caso de necessidade.

NOTA: Deve assegurar que o equipamento é instalado corretamente face ao negativo. Alinhe a furação do equipamento perante a furação do negativo conforme ilustra a imagem da instalação.



PORTUGAL  
[www.bragmaia.com](http://www.bragmaia.com)  
[geral@bragmaia.com](mailto:geral@bragmaia.com)  
Tlf. (+351) 273 302 440



PORTUGAL  
[www.bragmaia.com](http://www.bragmaia.com)  
[geral@bragmaia.com](mailto:geral@bragmaia.com)  
Tlf. (+351) 273 302 440

**brag**  
*PLAY*

**brag**  
*URBAN*

**brag**  
*SPORT*



## FUNÇÕES DESPORTIVAS

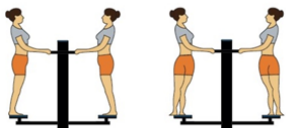

### CINTURA TRIPLA MODO DE EXECUÇÃO

Agarre o volante do aparelho com ambas as mãos, suba de frente para a placa redonda do aparelho com ambos os pés e rode a bacia para ambos os lados alternadamente. Postura bípede normal, olhar para a frente com o queixo na posição normal.

### MÚSCULOS ENVOLVIDOS

Reforça e desenvolve os músculos superiores, tais como peitorais, abdominais e tríceps, o que melhora a postura e a flexibilidade dos praticantes.



### EFEITOS BENÉFICOS DO EXERCÍCIO

Praticar exercício permite nutrir o espírito de equipa e de resiliência, bem como desenvolver os efeitos benéficos seguintes:

**FÍSICOS:** limita os riscos de obesidade, de osteoporose, de hipertensão e de doenças cardíacas. Reduz o risco de desenvolver dores lombares, tensão muscular e alivia a dor crónica. Ajuda no crescimento e a manutenção de ossos, músculos e articulações saudáveis. O ato de desgastar e reforçar o seu corpo com exercícios fortalece o sistema imunitário.

**MENTAIS:** relaxar permita a libertação de endorfinas neurotransmissores, que proporcionam o bem-estar psicológico. Exercitar-se com regularidade evita o aparecimento de sintomas de stress, reduz a ansiedade e a depressão. Estimula a autoestima e melhora consideravelmente as condições de sono. Ajuda o cérebro a recuperar a energia necessária para trabalhar corretamente, ajudando a desenvolver uma boa memória e pensamentos mais nítidos.

## NORMAS



EN 16630

Equipamentos de fitness fixos instalados no exterior  
Requisitos gerais de segurança e métodos de ensaio

## CONFIDENCIALIDADE E PROPRIEDADE INTELECTUAL

A informação contida neste documento é confidencial, não podendo o destinatário do mesmo reproduzi-la ou permitir a terceiros que a obtenham, utilizem ou divulguem sem a prévia e expressa autorização da BRAGMAIA.

Todos os direitos de propriedade intelectual sobre os desenhos e modelos apresentados são da titularidade exclusiva da BRAGMAIA, sendo expressamente proibida a prática de qualquer ato de exploração dos mesmos sem o consentimento desta, nos termos do código da propriedade industrial e do código do direito de autor e dos direitos conexos. A violação da obrigação de confidencialidade e/ou dos direitos de propriedade intelectual da BRAGMAIA, pode dar origem a responsabilidade civil e criminal.



PORTUGAL  
[www.bragmaia.com](http://www.bragmaia.com)  
[geral@bragmaia.com](mailto:geral@bragmaia.com)  
Tlf. (+351) 273 302 440



PORTUGAL  
[www.bragmaia.com](http://www.bragmaia.com)  
[geral@bragmaia.com](mailto:geral@bragmaia.com)  
Tlf. (+351) 273 302 440

**brag**  
*PLAY*

**brag**  
*URBAN*

**brag**  
*SPORT*



PORTUGAL  
[www.bragmaia.com](http://www.bragmaia.com)  
[geral@bragmaia.com](mailto:geral@bragmaia.com)  
Tlf. (+351) 273 302 440

**brag**  
*PLAY*

**brag**  
*URBAN*

**brag**  
*SPORT*



PORTUGAL  
[www.bragmaia.com](http://www.bragmaia.com)  
[geral@bragmaia.com](mailto:geral@bragmaia.com)  
Tlf. (+351) 273 302 440

**brag**  
*PLAY*

**brag**  
*URBAN*

**brag**  
*SPORT*

## DESCRIPCIÓN

Equipo BragSPORT, biosaludable CINTURA TRIPLE, para ejercitar la musculatura de la cintura pélvica, de la zona abdominal y lumbar. Compuesto por estructura en tubos central estructural Ø114,3x3mm y el resto de tubos de Ø101,60x3mm, Ø50x50x3mm y chapa en acero inoxidable 316. Paneles Bragpo azul y placa de instrucciones de PVC con impresión digital y laminado. Rodamientos esféricos de acero electrozincado y herrajes de acero inoxidable. Fijación al suelo X (atornillar). Con opción adicional de soporte Y (hormigonar).



Medidas generales (LxAxA): 913x1005x1198mm  
Área de seguridad: 16m<sup>2</sup> | Área libre: 3913x4005mm  
Grupo de edad: +12 años  
Número de usuarios: 3

## CARACTERÍSTICAS TÉCNICAS

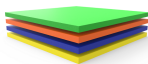

### BRAGPO

BragPO HDPE de alta densidad monocolor o bicolor, sin HPA. Caracterizado por su extrema ligereza y elasticidad, resistencia a productos químicos, corrosión, rayos UV (UNE EN ISO 4892), a la inflamabilidad (UNE-EN ISO 11925-2) y al impacto (ISO 527-1). No necesita ningún tipo de mantenimiento.  
Garantía: 15 años



### RODAMIENTO ESFÉRICO

Rodamientos esféricos rígidos de una hilera con junta de goma de cierre, según DIN 925-1.



### HERRAJES EN ACERO INOX

Herrajes en acero inox, según NF EN 10088, protegidos por cápsulas en polipropileno PP.

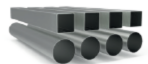

### TUBO ACERO INOX AISI 316

Tubo en acero inoxidable AISI 316, según la norma EN 14401, con refinamiento 2B.  
Garantía: 15 años



PORTUGAL  
[www.bragmaia.com](http://www.bragmaia.com)  
[geral@bragmaia.com](mailto:geral@bragmaia.com)  
Tlf. (+351) 273 302 440



PORTUGAL  
[www.bragmaia.com](http://www.bragmaia.com)  
[geral@bragmaia.com](mailto:geral@bragmaia.com)  
Tlf. (+351) 273 302 440

**brag**  
*PLAY*

**brag**  
*URBAN*

**brag**  
*SPORT*

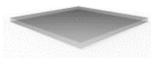

**CHAPA EN ACERO INOX AISI 316**

Chapa en acero lisa (EN 10327) acero laminado en caliente (EN 10027-1 y CR 10260), en acero inoxidable AISI 304, según norma EN 14301, con refinamiento 2B.



**PLACA GERIÁTRICA**

Fabricada en chapa de PVC rígido con 170x170x10mm, de moldeo simple, con alta resistencia a productos químicos, resistente a los impactos, auto extingible (Clase M1), excelente aislamiento eléctrico y térmico y no es tóxico. Impresión digital en varios colores sobre vinilo con acabado laminado, con protección UV y anti grafiti.



**SISTEMA DE FIJACIÓN**

Tipo X - Sistema de fijación compuesto por una base metálica y atornillada al suelo rígido.

Tipo Y - Opcional, compuesto por una base metálica o poste embutido al suelo y con relleno de hormigón.

El soporte metálico está fabricado en tubo Ø114mm y chapa de acero de carbono, con tratamiento anticorrosivo de galvanización por inmersión en caliente con un espesor entre 120 y 140µm de acuerdo con la norma EN ISO 1461, que permite su colocación sin que el poste entre en contacto directo con el suelo. Su fijación al suelo es realizado por un sistema de sujeción rápido aumentando la longevidad del poste y su fácil y rápida sustitución en caso de necesidad.

NOTA: Debe asegurarse de que el equipo se instala correctamente frente al negativo. Alinee el taladro del equipo perante el taladro del negativo como ilustra la imagen de la instalación.



PORTUGAL  
[www.bragmaia.com](http://www.bragmaia.com)  
[geral@bragmaia.com](mailto:geral@bragmaia.com)  
Tlf. (+351) 273 302 440



PORTUGAL  
[www.bragmaia.com](http://www.bragmaia.com)  
[geral@bragmaia.com](mailto:geral@bragmaia.com)  
Tlf. (+351) 273 302 440

**brag**  
*PLAY*

**brag**  
*URBAN*

**brag**  
*SPORT*



## FUNCIONES DEPORTIVAS

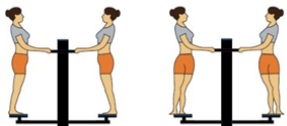

### CINTURÓN TRIPLE MODO DE EJECUCIÓN

Sujete el volante del aparato con ambas manos, gire hacia las pedaleras con ambos pies y deslice la plataforma. Gire hacia ambos lados alternativamente. Postura bípeda normal, mirar hacia la frente.

### MÚSCULOS IMPLICADOS

Fortalece y desarrolla los músculos superiores, como pectorales, abdominales y tríceps, lo que mejora la postura y la flexibilidad de los practicantes.



### EFECTOS BENEFICIOSOS DEL EJERCICIO

Practicar ejercicio permite alimentar el espíritu de equipo, así como desarrollar los siguientes niveles:

**FÍSICOS:** limita los riesgos de obesidad, osteoporosis, hipertensión y enfermedades cardíacas. Reduce el riesgo de desarrollar dolor lumbar, tensión muscular y alivia el dolor crónico. Ayuda en el crecimiento y al aturdimiento de huesos, músculos y articulaciones saludables. Fortalece el sistema inmunológico.

**MENTALES:** relajar permite la liberación de endorfinas neurotransmisoras, que proporcionan el bienestar psicológico. Hacer ejercicio con regularidad evita la aparición de síntomas de estrés, reduce la ansiedad y la depresión. Estimula la autoestima y mejora considerablemente las condiciones de sueño. Ayuda al cerebro a recuperar la energía necesaria para trabajar correctamente, ayudando a desarrollar una buena memoria y pensamientos más nítidos.

## NORMAS



EN 16630

Equipos fijos de entrenamiento físico instalados al aire libre  
Requisitos de seguridad y métodos de ensayo

## CONFIDENCIALIDAD Y PROPIEDAD INTELECTUAL

La información contenida en este documento es estrictamente confidencial, no pudiendo el destinatario reproducirla o permitir a terceros que la adquieran, utilicen o divulguen sin la previa y expresa autorización de BRAGMAIA.

Todos los derechos de propiedad intelectual sobre los diseños y modelos presentados son de titularidad exclusiva de BRAGMAIA, estando expresamente prohibida la práctica de cualquier acto de usurpación de los mismos sin el previo consentimiento de la empresa, dentro de los términos del código de propiedad industrial y del código de derechos de autor y derechos análogos. La violación de la obligación de confidencialidad y/o de los derechos de propiedad intelectual de BRAGMAIA, puede dar origen a responsabilidad civil y criminal.



PORTUGAL  
[www.bragmaia.com](http://www.bragmaia.com)  
[geral@bragmaia.com](mailto:geral@bragmaia.com)  
Tlf. (+351) 273 302 440

brag  
PLAY

brag  
URBAN

brag  
SPORT



PORTUGAL  
[www.bragmaia.com](http://www.bragmaia.com)  
[geral@bragmaia.com](mailto:geral@bragmaia.com)  
Tlf. (+351) 273 302 440

**brag**  
*PLAY*

**brag**  
*URBAN*

**brag**  
*SPORT*



PORTUGAL  
[www.bragmaia.com](http://www.bragmaia.com)  
[geral@bragmaia.com](mailto:geral@bragmaia.com)  
Tlf. (+351) 273 302 440

**brag**  
*PLAY*

**brag**  
*URBAN*

**brag**  
*SPORT*



PORTUGAL  
[www.bragmaia.com](http://www.bragmaia.com)  
[geral@bragmaia.com](mailto:geral@bragmaia.com)  
Tlf. (+351) 273 302 440

**brag**  
*PLAY*

**brag**  
*URBAN*

**brag**  
*SPORT*

## DESCRIPTION

BragSPORT equipment, biohealthy TRIPLE WAIST, to exercise the musculature of the pelvic waist, abdominal and lumbar area. Composed of structural central tube structure Ø114,3x3mm and remaining pipes Ø101,60x3mm, 50x50x3mm and 316 stainless steel sheet. Panels Bragpo blue and PVC instruction board with digital printing and lamination. Spherical bearings in electro-zinc plated steel and stainless steel fittings. Ground attachment X (screw). With additional support option Y (concreting).



General measures (LxWxH): 913x1005x1198mm  
Security area: 16m<sup>2</sup> | Free area: 3913x4005mm  
Age group: +12 years old  
Number of users: 3

## TECHNICAL FEATURES

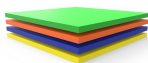

### BRAGPO

BragPO HDPE of high density in one color or bicolor, free of HPA. Characterized by its extreme lightness and elasticity, resistance to chemicals, corrosion, UV rays (UNE EN ISO 4892), to flammability (UNE-EN ISO 11925-2) and impact (ISO 527-1). It doesn't need any maintenance.  
Guarantee: 15 years.



### SPHERICAL BEARING

Single row rigid spherical ball bearings with rubber seal for closing, in accordance with DIN 925-1.



### STAINLESS STEEL HARDWARE

Stainless steel, in accordance with NF EN 10088, protected by polypropylene PP capsules.

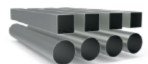

### STAINLESS STEEL TUBE AISI 316

Tube in stainless steel AISI 316, according to EN 14401, with finish 2B.  
Guarantee: 15 years



PORTUGAL  
[www.bragmaia.com](http://www.bragmaia.com)  
[geral@bragmaia.com](mailto:geral@bragmaia.com)  
Tlf. (+351) 273 302 440



PORTUGAL  
[www.bragmaia.com](http://www.bragmaia.com)  
[geral@bragmaia.com](mailto:geral@bragmaia.com)  
Tlf. (+351) 273 302 440

**brag**  
*PLAY*

**brag**  
*URBAN*

**brag**  
*SPORT*

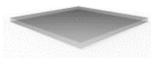

**STAINLESS STEEL PLATE AISI 316**

Smooth stainless steel plate (EN 10327) hot rolled steel (EN 10027-1 e CR 10260), with stainless steel AISI 304, according to EN 14401, with finish 2B.



**GERIATRIC PLAQUE**

Made of hard PVC sheet with 170x170x10mm, simple molding, with high chemical resistance, impact resistant, self-extinguishing (Class M1), excellent electrical and thermal insulation and is not toxic. Digital printing in various colors on vinyl with laminated finish, with UV protection and anti graffiti.



**FASTENING SYSTEM**

Type X - Fixation system composed of a metal base bolted to the hard ground.

Type Y - Optional, composed of built-in metal base or plumbing applied directly to the ground and concrete sinker.

The metal support is made of Ø114mm tube and carbon steel plate, with corrosion-resistant hot dip galvanisation treatment between 120 and 140µm thick according to EN ISO 1461, which allows its placement without the plumb line coming into direct contact with the ground. Its attachment to the plumb line is made by a quick clamping system increasing the longevity of the plumb line and its easy and fast replacement in case of need.

NOTE: You must ensure that the equipment is installed correctly against the negative. Align the drilling of the equipment with the drilling of the negative as illustrated in the image of the installation.



PORTUGAL  
[www.bragmaia.com](http://www.bragmaia.com)  
[geral@bragmaia.com](mailto:geral@bragmaia.com)  
Tlf. (+351) 273 302 440



PORTUGAL  
[www.bragmaia.com](http://www.bragmaia.com)  
[geral@bragmaia.com](mailto:geral@bragmaia.com)  
Tlf. (+351) 273 302 440

**brag**  
*PLAY*

**brag**  
*URBAN*

**brag**  
*SPORT*



## SPORTS FUNCTIONS

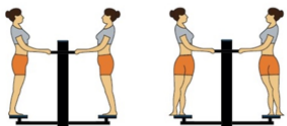

### TRIPLE WAIST EXECUTION MODE

Grasp the steering wheel of the appliance with both hands, face the round plate of the appliance with both feet and rotate the bowl to both sides alternately. Normal biped posture, look forward with the chin in the normal position.

### MUSCLES INVOLVED

Strengthens and develops the upper muscles, such as pectorals, abdominals and triceps, which improves the posture and flexibility of practitioners.



### BENEFICIAL EFFECTS OF EXERCISE

Practicing exercise allows you to nurture team spirit and resilience, as well as develop the following beneficial effects:

**PHYSICS:** it limits the risks of obesity, osteoporosis, hypertension and heart disease. It reduces the risk of developing back pain, muscle tension and relieves chronic pain. Helps in the growth and maintenance of healthy bones, muscles and joints. The act of wearing and strengthening your body with exercises strengthens the immune system.

**MENTAL:** relax allow the release of endorphins neurotransmitters, which provide psychological well-being. Regular exercise prevents the onset of stress symptoms, reduces anxiety and depression. It stimulates self-esteem and considerably improves sleep conditions. Helps the brain recover the energy needed to work properly, helping to develop a good memory and sharper thoughts.

## STANDARTS



EN 16630

Permanently installed outdoor fitness equipment  
Safety requirements and test methods

## CONFIDENTIALITY AND INTELLECTUAL PROPERTY

The information contained in this document is confidential, and the recipient cannot reproduce it or allow third parties to obtain, use or disclose it without the prior and express authorization of BRAGMAIA.

All intellectual property rights over the designs and models presented are the exclusive property of BRAGMAIA, and the practice of any act of exploitation thereof without the consent of the latter, under the terms of the industrial property code and the copyright code and related rights. Violation of BRAGMAIA's obligation of confidentiality and / or intellectual property rights may give rise to civil and criminal liability.



PORTUGAL  
[www.bragmaia.com](http://www.bragmaia.com)  
[geral@bragmaia.com](mailto:geral@bragmaia.com)  
Tlf. (+351) 273 302 440



PORTUGAL  
[www.bragmaia.com](http://www.bragmaia.com)  
[geral@bragmaia.com](mailto:geral@bragmaia.com)  
Tlf. (+351) 273 302 440

**brag**  
*PLAY*

**brag**  
*URBAN*

**brag**  
*SPORT*



PORTUGAL  
[www.bragmaia.com](http://www.bragmaia.com)  
[geral@bragmaia.com](mailto:geral@bragmaia.com)  
Tlf. (+351) 273 302 440

**brag**  
*PLAY*

**brag**  
*URBAN*

**brag**  
*SPORT*



PORTUGAL  
[www.bragmaia.com](http://www.bragmaia.com)  
[geral@bragmaia.com](mailto:geral@bragmaia.com)  
Tlf. (+351) 273 302 440

**brag**  
*PLAY*

**brag**  
*URBAN*

**brag**  
*SPORT*

## DESCRIPTION

Équipement BragSPORT, biosanté TAILLE TRIPLE, pour exercer la musculature de la ceinture pelvienne, de la zone abdominale et lombaire. Composé d'une structure de tubes centrale Ø114,3x3mm et les autres tubes de Ø101,60x3mm, 50x50x3mm et la tôle en acier inoxydable 316. Panneaux Bragpo bleu et plaque d'instructions en PVC avec empreinte digitale et laminage. Roulements sphériques en acier électrozingué et ferrures en acier inoxydable. Fixation au sol X (visser). Avec option supplémentaire de soutien Y (bétonner).



Mesures générales (LxLxH) : 913x1005x1198mm  
Zone de sécurité : 16m2 | Zone libre : 3913x4005mm  
Tranche d'âge : +12 ans  
Nombre d'utilisateurs : 3

## CARACTÉRISTIQUES TECHNIQUES

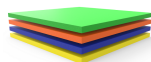

### BRAGPO

BragPO HDPE d'une couleur ou bicolore de haute densité, sans HPA. Caractérisé par son extrême légèreté et élasticité, résistante aux produits chimiques, à la corrosion, aux rayons UV (UNE EN ISO 4892), à l'inflammabilité (UNE-EN ISO 11925-2) et aux impacts (ISO 527-1). Pas d'entretien nécessaire.  
Garantie: 15 ans.



### ROULEMENT SPHÉRIQUE

Roulements à billes rigide, à une rangée avec joint en caoutchouc pour la fermeture, selon la norme DIN 925-1.



### FERRURES EN ACIER INOXYDABLE

Ferrures en acier inoxydable, selon la norme NF EN 10088, protégé par des capsules en polypropylène PP.

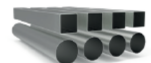

### TUBE EN ACIER INOXYDABLE AISI 316

Tube en acier inoxydable AISI 316, en accord avec la norme EN 14401, avec finition 2B.  
Garantie: 15 ans



PORTUGAL  
[www.bragmaia.com](http://www.bragmaia.com)  
[geral@bragmaia.com](mailto:geral@bragmaia.com)  
Tlf. (+351) 273 302 440



PORTUGAL  
[www.bragmaia.com](http://www.bragmaia.com)  
[geral@bragmaia.com](mailto:geral@bragmaia.com)  
Tlf. (+351) 273 302 440

**brag**  
*PLAY*

**brag**  
*URBAN*

**brag**  
*SPORT*

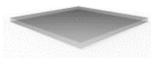

**TÔLE EN ACIER INOXYDABLE AISI 316:**

Tôle en acier inoxydable (EN 10327), en acier laminé à chaud (EN 10027-1 et CR 10260), en acier inoxydable AISI 316, en accord avec la norme EN 14401, avec finition 2B.



**PLAQUE GÉRIATRIQUE**

Fabriqué en PVC rigide 170x170x10mm, moulage simple, haute résistance aux produits chimiques, résistant aux chocs, auto-extinguible (classe M1), excellente isolation électrique et thermique et non toxique. Impression numérique en différentes couleurs sur le vinyle avec finition laminée, avec protection UV et anti graphite.



**SYSTÈME DE FIXATION**

Type X - Système de fixation composé d'une base métallique fixée au sol rigide.

Type Y - En option, composé d'une base métallique encastrée ou d'une poutre appliquée directement au sol et bétonnée

Le support métallique est fabriqué en tube Ø114mm et en tôle d'acier au carbone, avec traitement anticorrosif par galvanisation par immersion à chaud d'une épaisseur comprise entre 120 et 140µm selon la norme EN ISO 1461, qui permet de le placer sans contact direct avec le sol. Sa fixation à la tige est réalisée par un système de serrage rapide augmentant la longévité de la tige et son remplacement facile et rapide en cas de besoin.

NOTE : Vous devez vous assurer que l'équipement est correctement installé par rapport au négatif. Aligner la perforation de l'équipement conformément à l'image de l'installation.



PORTUGAL  
[www.bragmaia.com](http://www.bragmaia.com)  
[geral@bragmaia.com](mailto:geral@bragmaia.com)  
Tlf. (+351) 273 302 440



PORTUGAL  
[www.bragmaia.com](http://www.bragmaia.com)  
[geral@bragmaia.com](mailto:geral@bragmaia.com)  
Tlf. (+351) 273 302 440

**brag**  
*PLAY*

**brag**  
*URBAN*

**brag**  
*SPORT*



## FONCTIONS SPORTIVES

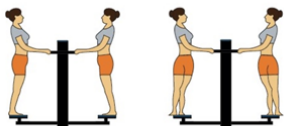

### TRIPLE TAILLE MODE D'EXÉCUTION

Saisissez le volant de l'appareil à deux mains, faites face à la plaque ronde de l'appareil avec les deux pieds et tournez le bol des deux côtés en alternance. Posture bipède normale, regardez en avant avec le menton en position normale.

### MUSCLES IMPLIQUÉS

Renforce et développe les muscles supérieurs, tels que les pectoraux, les abdominaux et les triceps, ce qui améliore la posture et la flexibilité des pratiquants.



### EFFETS BÉNÉFIQUES DE L'EXERCICE

Pratiquer l'exercice permet de nourrir l'esprit d'équipe et de résilience, ainsi que de développer les effets bénéfiques suivants:

**PHYSIQUES:** elle limite les risques d'obésité, d'ostéoporose, d'hypertension et de maladies cardiaques. Réduit le risque de développer des douleurs lombaires, la tension musculaire et soulage la douleur chronique. Aide à la croissance et le maintien des os, des muscles et des articulations sains. L'usure et le renforcement de votre corps avec des exercices renforce le système immunitaire.

**MENTAUX:** la relaxation permet la libération d'endorphines neurotransmetteurs, qui fournissent le bien-être psychologique. L'exercice régulier évite l'apparition de symptômes de stress, réduit l'anxiété et la dépression. Stimule l'estime de soi et améliore considérablement les conditions de sommeil. Aide le cerveau à récupérer l'énergie nécessaire pour travailler correctement, aidant à développer une bonne mémoire et des pensées plus claires.



PORTUGAL  
[www.bragmaia.com](http://www.bragmaia.com)  
[geral@bragmaia.com](mailto:geral@bragmaia.com)  
Tlf. (+351) 273 302 440



PORTUGAL  
[www.bragmaia.com](http://www.bragmaia.com)  
[geral@bragmaia.com](mailto:geral@bragmaia.com)  
Tlf. (+351) 273 302 440

**brag**  
*PLAY*

**brag**  
*URBAN*

**brag**  
*SPORT*

## NORMES



EN 16630  
Modules fixes d'entraînement physique de plein air  
Exigences de sécurité et méthodes d'essai

## CONFIDENTIALITÉ ET PROPRIÉTÉ INTELLECTUELLE

Les informations contenues dans ce document sont confidentielles et le destinataire ne peut pas les reproduire ni permettre à des tiers de les obtenir, de les utiliser ou de les divulguer sans l'autorisation préalable et expresse de BRAGMAIA.  
Tous les droits de propriété intellectuelle sur les dessins et modèles présentés sont propriété exclusive de BRAGMAIA, et la pratique d'un acte d'exploitation de ceux-ci sans le consentement de cette dernière, selon les termes du code de la propriété industrielle et du code du droit d'auteur et des droits voisins. La violation de l'obligation de confidentialité et / ou des droits de propriété intellectuelle de BRAGMAIA peut engager à la responsabilité civile et pénale.



PORTUGAL  
[www.bragmaia.com](http://www.bragmaia.com)  
[geral@bragmaia.com](mailto:geral@bragmaia.com)  
Tlf. (+351) 273 302 440



PORTUGAL  
[www.bragmaia.com](http://www.bragmaia.com)  
[geral@bragmaia.com](mailto:geral@bragmaia.com)  
Tlf. (+351) 273 302 440

**brag**  
*PLAY*

**brag**  
*URBAN*

**brag**  
*SPORT*