

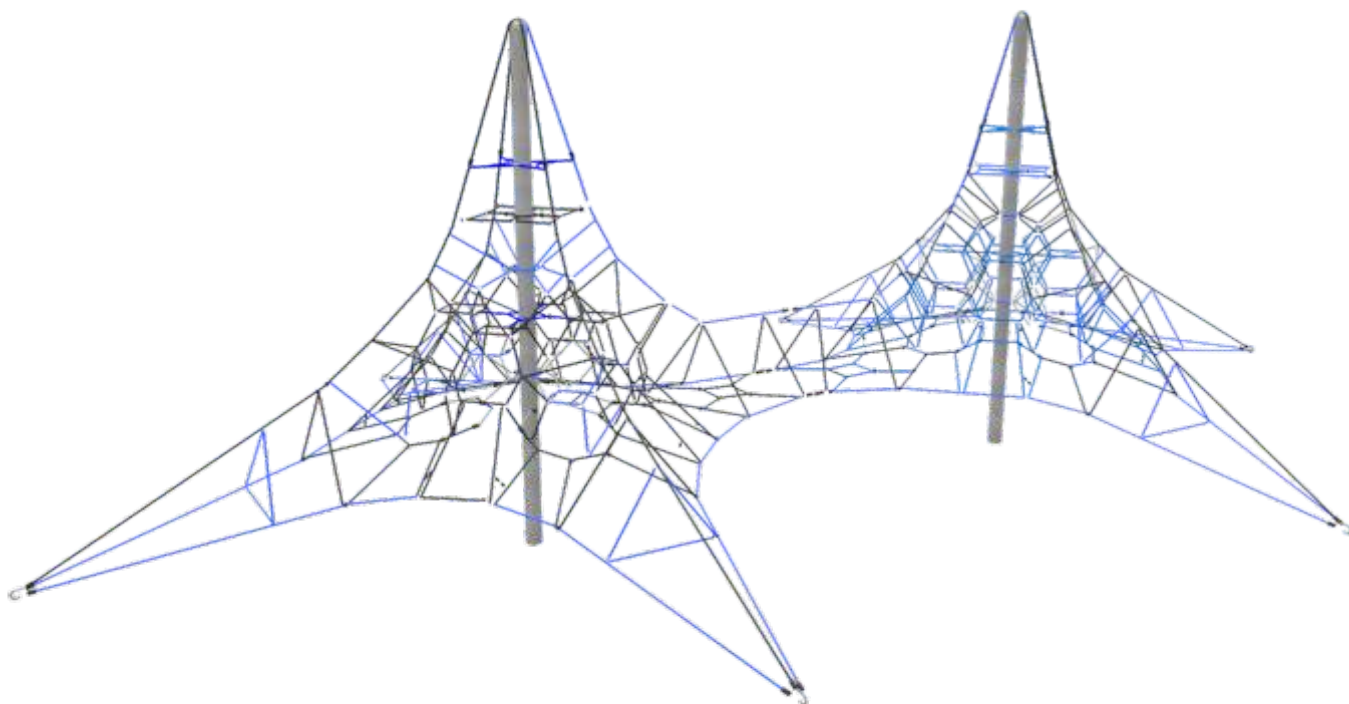



PIRÂMIDE TRIDIMENSIONAL DUPLA

PT60000



			
351m ²	0,70m	+2	45

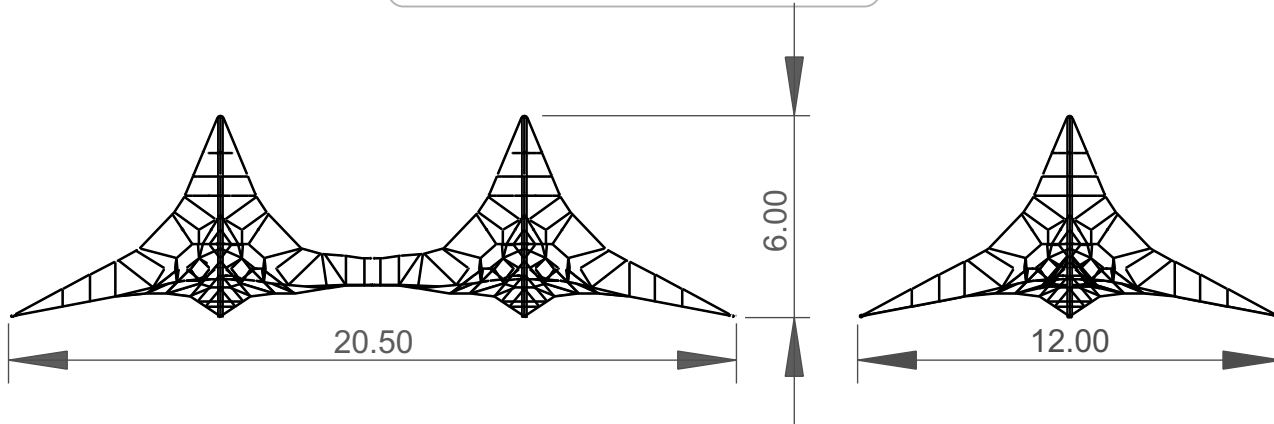



— Zona de impacto

- - Espaço livre

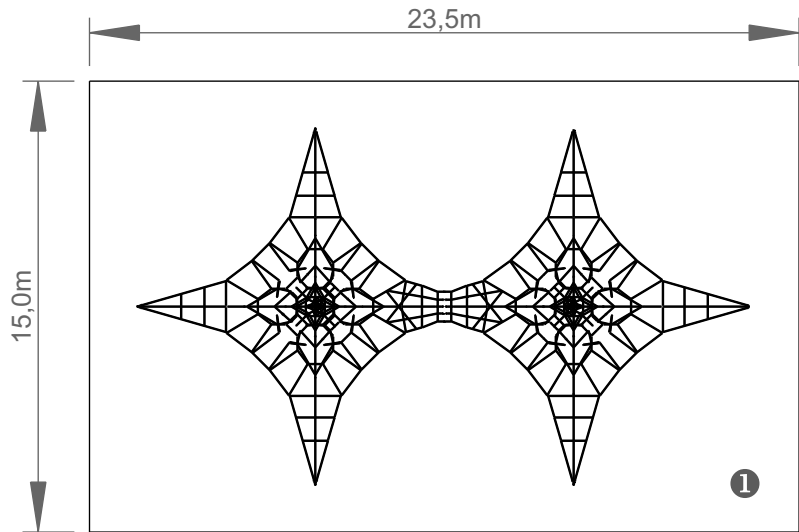
EN 1176-1 



.....	①
	0,70
	351
	351

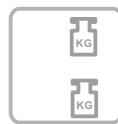

INFORMAÇÃO TÉCNICA / INFORMACIÓN TÉCNICA / TECHNICAL INFORMATION / INFORMATIONS TECHNIQUES

1 - Pirâmide Tridimensional  0,70m

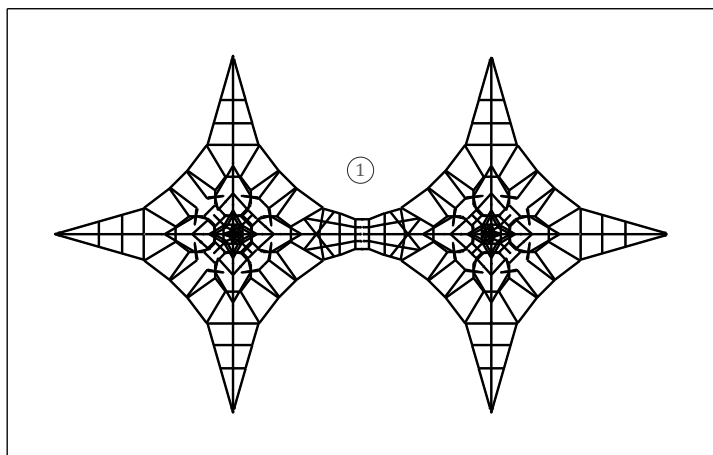



Rede

cordas Ø16mm reforçadas em aço revestido por fibras de polipropileno, acessórios de ligação e fixação em plástico HDPE com protecção U.V., elementos de fixação em aço galvanizado a quente;

Peças Metálicas

Mastro

Aço Inox AISI 304;

Sistema de fixação

Tipo C – Sistema de fixação standard composto por prumo aplicado directamente no solo e chumbado com betão;

Parafusos e acessórios

Parafusos: Aço zincado ou opcionalmente aço inox AISI 304;

Cápsulas: Plástico polipropileno PP;





FUNÇÕES LÚDICAS / FUNCIONES LÚDICAS / RECREATIONAL FUNCTIONS / FONCTIONS RÉCRÉATIVES



Divertir: Enquanto se divertem, as crianças adquirem imensas capacidades, desde habilidades físicas a interações sociais.



Socializar: A socialização e a imaginação são necessárias em todo o jogo. Tudo isso cria relação entre crianças e desperta o senso de convivência e a solidariedade.



Jogar: Desenvolve a paciência, a partilha e o espírito desportivo.



Trepar: Desenvolve as capacidades motrizes das crianças, o controlo do próprio corpo, o equilíbrio e a coordenação, estimulando a capacidade motora e a força nos movimentos.



Rede

Cuerdas \varnothing 16 mm reforzadas con acero revestido con fibras de polipropileno, accesorios de enlace y fijación de plástico HDPE con protección U.V., elementos de sujeción de acero galvanizado en caliente.

Piezas metálicas

mástil

Acero Inox AISI 304;

Sistema de fijación

TIPO C - Sistema de fijación estándar aplicado directamente al suelo y aplomado con hormigón.

Tornillería y accesorios

Tornillos: Acero galvanizado electrolítico u opcionalmente acero inoxidable AISI 304;

Cápsulas: Plástico de polipropileno PP;





FUNÇÕES LÚDICAS / FUNCIONES LÚDICAS / RECREATIONAL FUNCTIONS / FONCTIONS RÉCRÉATIVES



Divertir: Los niños, mientras se divierten, desarrollan una parte importante de sus capacidades, ya sean físicas, psicomotoras hasta interacciones sociales.



Socializar: Desarrollar la Socialización e imaginación son capacidades necesarias en los juegos de los niños; lo que conlleva a una relación interactiva entre ellos, despertando su sentido de convivencia y solidaridad.



Jugar: Desarrolla la tolerancia, el aprender a compartir, así como su espíritu deportivo.



Trepar: Se trata de un ejercicio idóneo para el desarrollo de las habilidades motrices de los niños, del control de su propio cuerpo, equilibrio y coordinación; estimulando, de esta manera, su capacidad motora y la seguridad en sus movimientos.



Net

ropes Ø16mm reinforced in steel covered by polypropylene fibers, fittings and connection in HDPE plastic with U.V. protection, fastening elements in hot galvanized steel;

Metal parts

Mast

AISI 304 stainless steel;

Fixation System

Type C - Standard fixing system composed of plumbing applied directly to the ground and cast with concrete;

Screws and accessories

Screws: Zinc-plated steel or optionally AISI 304 stainless steel;

Capsules: PP polypropylene plastic;





FUNÇÕES LÚDICAS / FUNCIONES LÚDICAS / RECREATIONAL FUNCTIONS / FONCTIONS RÉCRÉATIVES



Fun: While having fun, children acquire immense abilities, from physical abilities to social interactions.



Socialize: Socialization and imagination are necessary throughout the game. All this creates a relationship between children and awakens the sense of coexistence and solidarity.



Play: Develops patience, sharing and sporting spirit.



Climb: It develops children's motor skills, body control, balance and coordination, stimulating motor ability and strength in movements.

Filet

cordes Ø16mm renforcées en acier recouvert de fibres de polypropylène, raccords et connexions en plastique HDPE avec protection UV, éléments de fixation en acier galvanisé à chaud;

Pièces en métal

Mât

Acier inoxydable AISI 304;

Système de fixation

Type C - Système de fixation standard composé d'une plomberie appliquée directement au sol et coulée avec du béton;

Vis et accessoires

Vis: Acier zingué ou, éventuellement, acier inoxydable AISI 304;

Capsules: polypropylène PP;





Amuser: tout en s'amusant, les enfants acquièrent d'énormes capacités, allant des capacités physiques aux interactions sociales.



Socialiser: la socialisation et l'imagination sont nécessaires tout au long du jeu. Tout cela crée une relation entre les enfants et éveille le sentiment de coexistence et de solidarité.



Jouer: Développe la patience, le partage et l'esprit sportif.



Escalader: développe les capacités motrices, le contrôle du corps, l'équilibre et la coordination des enfants, stimulant la capacité motrice et la force dans les mouvements.