

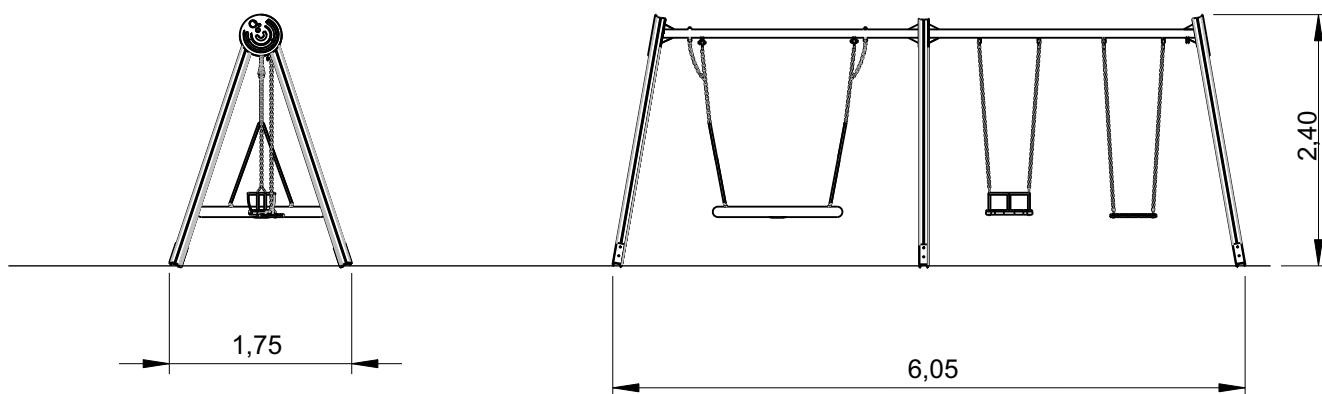

# ZEA 7 DUPLO

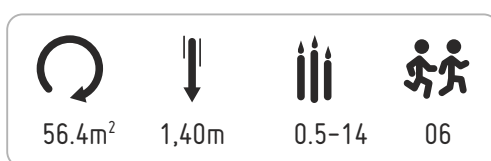

ELDANO29PCN-A



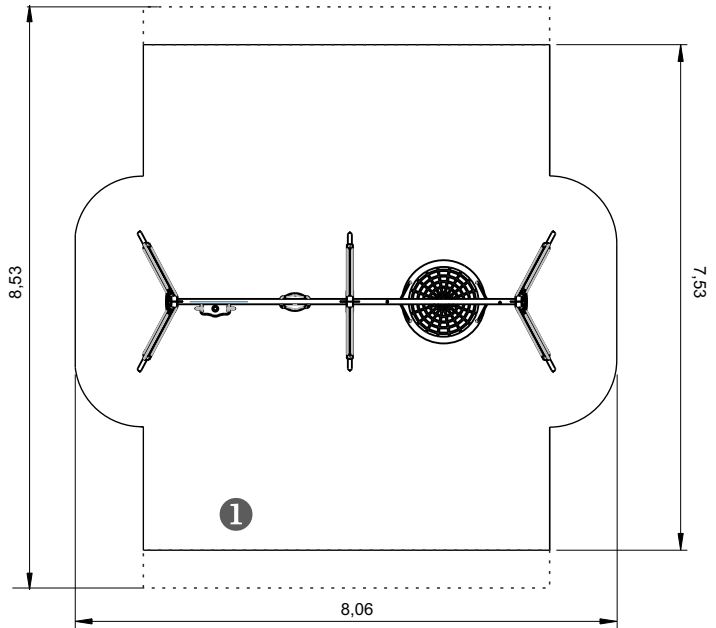

— Zona de impacto  
 - - Espaço livre

EN 1176-1,2 



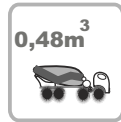

.....	①
	1,40
	56.4
m <sup>2</sup>	56.4



 PT:A área de segurança pode ser reduzida em 0.50cm em cada extremo, no caso de uso de superfície amortecedora sintética.  
 ES:El área de seguridad puede reducirse en 0,50 cm en cada extremo si se utiliza una superficie de amortiguación sintética.  
 EN:The safety area may be reduced by 0.50cm at each end if a synthetic damping surface is used.  
 FR:La zone de sécurité peut être réduite de 0,50 cm à chaque extrémité si une surface d'amortissement synthétique est utilisée.

INFORMAÇÃO TÉCNICA / INFORMACIÓN TÉCNICA / TECHNICAL INFORMATION / INFORMATIONS TECHNIQUES

- 1 - Assento  0.50m
- 2 - Baloço Ninho  0.60m
- 3- Cadeira de Bêbé  0.50m

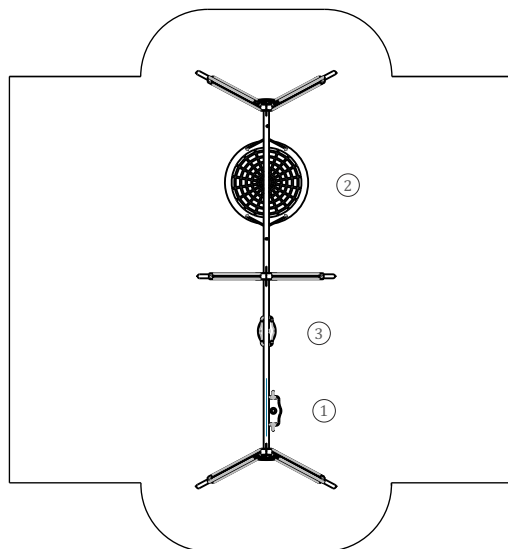



#### Prumos

Madeira: Pinho laminado classificado com qualidade de garantia por controlo interno contínuo. Com tratamento autoclave, protegendo-a dos ataques de cogumelos, insectos e térmitas. Acabamento final a tinta de base aquosa especialmente desenvolvida para proteger a madeira de humidades, intempéries e raios U.V.. Contém princípios activos que lhe conferem uma barreira protetora contra o aparecimento de fungos e bolores;

#### Painéis

HDPE: Polietileno de alta densidade monocolor ou bicolor. Por ser um polímero é caracterizado pela sua resistência a produtos químicos e à corrosão. Pela sua capacidade de elasticidade e leveza, oferece alta resistência ao impacto, sendo muito difícil quebrar. A superfície antiderrapante fornece segurança para as crianças e a sua base sintética impede o cultivo de bactérias e fungos. Não necessita de qualquer manutenção;

Cadeiras e assentos: Em borracha EPDM injetada, com reforço interior de alumínio. Correntes com Ø5mm em aço galvanizado a quente;

#### Peças Metálicas

Tubos: Ferro com tratamento anticorrosivo de galvanização por imersão a quente de acordo com a norma EN ISO 1461; Sistema de fixação: permitem a sua colocação no solo sem que a madeira entre em contacto directo com a terra. A parte inferior destes sistemas de fixação são ancorados no solo. Fabricados em chapa de aço galvanizado;

Tipo A – Sistema de fixação standard composto por base metálica embutida no solo e chumbada com betão;

#### Parafusos e acessórios

Parafusos: Aço zincado ou opcionalmente aço inox AISI 304;

Câpsulas: Plástico polipropileno PP;

**100%** 

**PROTECTORES DECORATIVOS:**

-  Penetra profundamente na madeira destacando os veios e embelezando a madeira com os seus cores especiais transparentes.
-  Muito resistente ao sol. Contém pigmentos micronizados absorventes e estabilizadores dos raios U.V.
-  Microporoso, deixa respirar a madeira e evita as deformações naturais da madeira.
-  Fácil manutenção. Não é necessário liar ou decapar para a aplicação de novas camadas.
-  Conferindo ao filme uma barreira protectora contra fungos e bolores.
-  **HIDRÓFUGO**  
protege contra a humidade, a chuva e impermeabiliza.



## FUNÇÕES LÚDICAS/ FUNCIONES LÚDICAS / RECREATIONAL FUNCTIONS / FONCTIONS RÉCRÉATIVES



#### Divertir

Enquanto se divertem, as crianças adquirem imensas capacidades, desde habilidades físicas a interações sociais.



#### Socializar

A socialização e a imaginação são necessárias em todo o jogo. Tudo isso cria relação entre crianças e desperta o senso de convivência e a solidariedade.



#### Jogar

Desenvolve a paciência, a partilha e o espírito desportivo.



#### Balançar

Este movimento proporciona o desenvolvimento do sistema nervoso, sobretudo ao nível psicomotor e da visão. Para além de ser tranquilizante, desenvolve ainda as capacidades de equilíbrio e coordenação.



Postes

Madera: Pino laminado clasificado con calidad de garantía por control interno continuo. Con tratamiento autoclave, protegiéndola de los ataques de setas, insectos y termitas. Acabado final a tinta de base acuosa especialmente desarrollada para proteger la madera de humedad, intemperie y rayos U.V .. Contiene principios activos que le confieren una barrera protectora contra la aparición de hongos y mohos;

paneles

HDPE: Polietileno de alta densidad monocolor o bicolor. Por ser un polímero se caracteriza por su resistencia a los productos químicos y a la corrosión. Por su capacidad de elasticidad y ligereza, ofrece alta resistencia al impacto, siendo muy difícil romper. La superficie antideslizante proporciona seguridad para los niños y su base sintética impide el cultivo de bacterias y hongos. No necesita mantenimiento;

Sillas y asientos: En goma EPDM inyectada, con refuerzo interior de aluminio. Cadenas con Ø5mm en acero galvanizado en caliente;

Piezas Metálicas

Tubos: Hierro con tratamiento anticorrosivo de galvanización por inmersión en caliente de acuerdo con la norma EN ISO 1461; Sistema de fijación: permiten su colocación en el suelo sin que la madera entre en contacto directo con la tierra. La parte inferior de estos sistemas de fijación se ancla en el suelo. Fabricados en chapa de acero galvanizado;

Tipo A – Sistema de fijación estándar compuesto por base metálica embutida en el suelo y plomada con hormigón;

Tornillos y accesorios

Tornillos: Acero zincado o opcionalmente acero inoxidable AISI 304;

Cápsulas: Plástico polipropileno PP;



100%

PROTECTORES DECORATIVOS:



Penetra profundamente en la madera destacando los vetas y embellece la madera con los sus colores especiales transparentes



Muy resistente al sol, contiene pigmentos micronizados absorbentes y estabilizadores de los rayos U.V.



Microporoso, deja respirar la madera y evita las deformaciones naturales de la madera.

PRINCIPIOS ACTIVOS



que le da a la película una barrera protectora contra los hongos y los mohos



protege contra la humedad, la lluvia e impermeabiliza.



FUNÇÕES LÚDICAS/ FUNCIONES LÚDICAS / RECREATIONAL FUNCTIONS / FONCTIONS RÉCRÉATIVES



Divertir

Mientras se divierten, los niños adquieren inmensas capacidades, desde habilidades físicas a interacciones sociales.



Socializar

La socialización y la imaginación son necesarias en todo el juego. Todo esto crea relación entre niños y despierta el sentido de convivencia y la solidaridad.



Jugar

Desarrolla la paciencia, el compartir y el espíritu deportivo.



oscilación

Este movimiento proporciona el desarrollo del sistema nervioso, sobre todo a nivel psicomotor y de la visión. Además de ser tranquilizante, desarrolla las capacidades de equilibrio y coordinación.



Plums

Wood: Laminated pine classified with guarantee quality by continuous internal control. With autoclave treatment, protecting it from attacks of mushrooms, insects and termites. Water-based paint finish specially developed to protect wood from moisture, weather and U.V. rays. Contains active principles that give it a protective barrier against the appearance of fungi and molds;

Panels

HDPE: High density polyethylene mono or two color. Being a polymer is characterized by its resistance to chemicals and corrosion. Due to its elasticity and lightness, it offers high impact resistance and is very difficult to break. The non-slip surface provides safety for children and its synthetic base prevents the growth of bacteria and fungi. It does not require any maintenance;

Chairs and seats: In EPDM injected rubber, with aluminum inner reinforcement. Chains with Ø5mm in hot galvanized steel;

Metal Pieces

Pipes: Hot dip galvanized hot rolled steel according to EN ISO 1461;

Fixation system: allows its placement on the ground without the wood coming into direct contact with the earth. The bottom of these fastening systems are anchored to the ground. Manufactured in galvanized sheet steel;

Type A – Standard fixing system composed of metal base embedded in the ground and cast with concrete;

Screws and accessories

Screws: Zinc-plated steel or optionally AISI 304 stainless steel;

Capsules: PP polypropylene plastic;

100%

DECORATIVE PROTECTORS:

Penetrates deep into wood highlighting and embellishing the wood with their special transparent colors

Very resistant to sun. Contains absorbent micronized pigments and UV stabilizers.

Microporous, let the wood breathe and prevents the natural deformations of the wood.

Easy maintenance. No sanding or pickling is required for the application of new layers.

PRINCÍPIOS ACTIVOS  
Giving the film a protective barrier against fungi and molds

HIDRÓFUGO  
protects against moisture, rain and waterproof.



FUNÇÕES LÚDICAS/ FUNCIONES LÚDICAS / RECREATIONAL FUNCTIONS / FONCTIONS RÉCRÉATIVES



Fun

While having fun, children acquire immense abilities, from physical abilities to social interactions.



Socializing

Socialization and imagination are necessary throughout the game. All this creates a relationship between children and awakens the sense of coexistence and solidarity.



Play

Develops patience, sharing and sporting spirit.



To swing

This movement provides the development of the nervous system, especially at the psychomotor and vision level. In addition to being tranquilizer, it also develops the skills of balance and coordination.

Poteaux

Bois: Pin stratifié classé avec une qualité garantie par contrôle interne continu. Avec traitement autoclave, le protégeant des attaques de champignons, d'insectes et de termites. Finition de peinture à base d'eau spécialement développée pour protéger le bois contre l'humidité, les intempéries et les rayons UV. Contient des principes actifs qui lui confèrent une barrière protectrice contre l'apparition de champignons et de moisissures;

Panneaux

HDPE: Polyéthylène haute densité mono ou bicolore. Être un polymère se caractérise par sa résistance aux produits chimiques et à la corrosion. Grâce à son élasticité et à sa légèreté, il offre une grande résistance aux chocs et est très difficile à briser. La surface antidérapante assure la sécurité des enfants et sa base synthétique empêche la croissance des bactéries et des champignons. Il ne nécessite aucun entretien.

Chaises et sièges: En caoutchouc injecté EPDM, avec renfort intérieur en aluminium. Chaînes avec Ø5mm en acier galvanisé à chaud;

Pièces Métalliques

Tubes: Acier laminé à chaud galvanisé à chaud selon la norme EN ISO 1461;

Système de fixation: permet son placement sur le sol sans que le bois entre en contact direct avec la terre. Le fond de ces systèmes de fixation est ancré au sol. Fabriqué en tôle d'acier galvanisée;

Type A – Système de fixation standard composé d'une base en métal noyée dans le sol et coulée avec du béton;







Vis et accessoires

Vis: Acier zingué ou acier inoxydable AISI 304 en option;

Capsules: PP polypropylène plastique;

100% 

**PROTECTEURS DÉCORATIFS:**

-  Pénètre profondément dans le bois en soulignant les veines et en embellissant le bois avec ses couleurs transparentes spéciales.
-  Très résistant au soleil il contient des pigments micronisés d'absorption des stabilisants UV.
-  Microporeux, laisse respirer le bois et empêche les déformations naturelles du bois.
-  Facile d'entretien. Aucun ponçage ou décapage n'est requis pour l'application de nouvelles couches.
-  Donne au film une barrière protectrice contre les champignons et les moisissures.
-  **HIDRÓFUGO**  
protège contre l'humidité, la pluie et imperméable.



Amusement

Tout en s'amusant, les enfants acquièrent d'immenses capacités, des capacités physiques aux interactions sociales.



Socialiser

La socialisation et l'imagination sont nécessaires tout au long du jeu. Tout cela crée une relation entre les enfants et éveille le sens de la coexistence et de la solidarité.



Jeu

Développe la patience, le partage et l'esprit sportif.



Balancer

Ce mouvement assure le développement du système nerveux, en particulier au niveau psychomoteur et visuel. En plus d'être tranquilisant, il développe également les compétences d'équilibre et de coordination.