

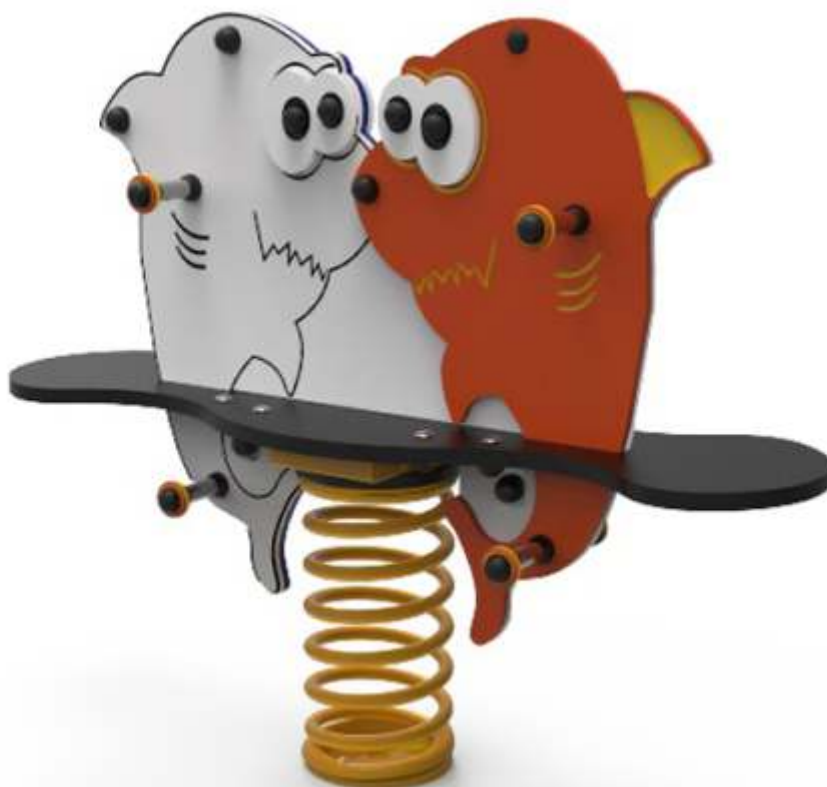



TUBARÃO

ELMOL039



			
14m ²	0,48m	2-8	02

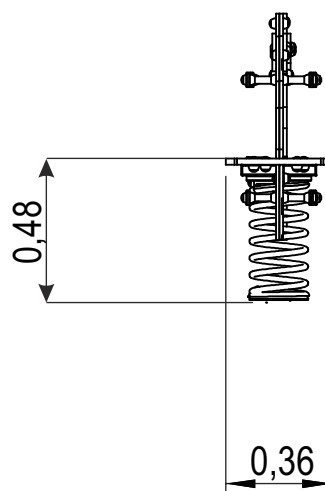
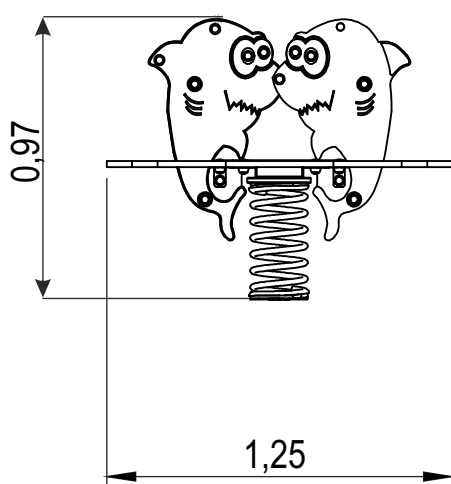

Utilização do equipamento sujeito a condições vigiadas; Zona de segurança: Área mínima requerida pela norma EN 1176-1,6
 Utilización del equipo sujeto a condiciones vigiladas; Zona de seguridad: Área mínima requerida por la norma EN 1176-1,6
 Use of equipment subject to supervised conditions; Safety zone: Minimum area required by EN 1176-1,6
 Utilisation d'équipement soumis à des conditions supervisées; Zone de sécurité: Surface minimale requise par l'EN 1176-1,6





— Zona de impacto

- - Espaço livre

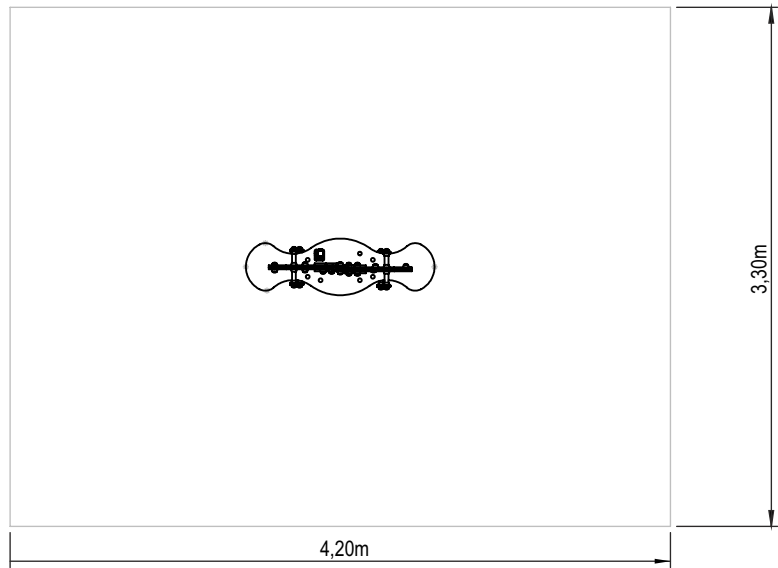
EN 1176-1,6



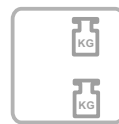
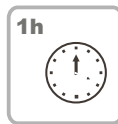
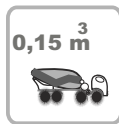

.....	①
	0,48
	14
	14

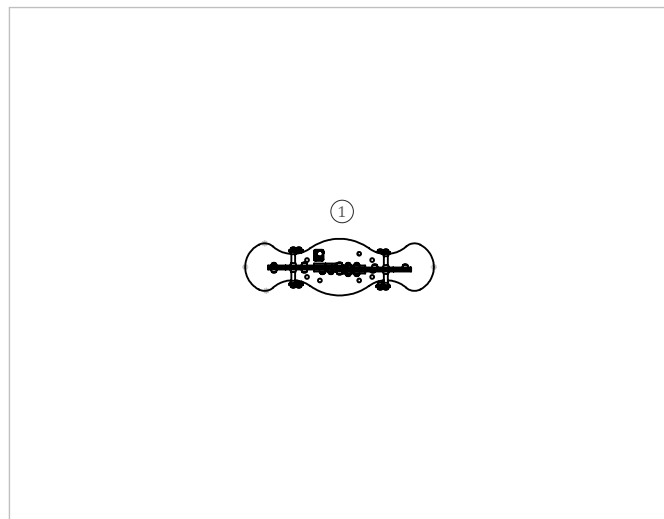

INFORMAÇÃO TÉCNICA / INFORMACIÓN TÉCNICA / TECHNICAL INFORMATION / INFORMATIONS TECHNIQUES

1 - Mola Tubarão  0.48m





Painéis

HDPE: Polietileno de alta densidade monocolor ou bicolor, livre de HPA. É um polímero de extrema leveza e elasticidade caracterizado pela resistência a produtos químicos, corrosão, raios UV (UNE EN ISO 4892), alta resistência à inflamabilidade (UNE-EN ISO 11925-2) e resistência a impactos (ISO 527-1). Não necessita de qualquer manutenção;

Peças Metálicas

Mola: Helicoidal em aço 35 SCD controlada em campo magnetoscópico;

Tubos

Aço Inox: AISI 304 de acordo com a norma EN 1.4301;

Ferro: Aço carbono S235JR/S275, laminado a quente;

Tratamentos de Superfícies

Galvanização: Tratamento anticorrosivo de galvanização por imersão a quente espessura entre 100 a 140µm de acordo com a norma EN ISO 1461.

Decapagem: Processo por jato abrasivo para limpeza da superfície metálica de oxidações e impurezas, garantindo um perfil de rugosidade ideal para o processo de tratamento de superfície; de acordo com a norma 8501:1;

Primário: A epóxi de poliéster anticorrosivo, ecológico com proteção de nível C4, com cozedura a 210°C;

Lacagem: Pintura electrostática a tinta em pó de poliéster com cozedura 230°C, espessura entre 100 a 120µm, de acordo com a norma UNE EN ISO 2808;

Negativo

Fabricados em chapa de aço galvanizado, permitem a sua colocação sem que o prumo entre em contacto direto com o solo. A sua fixação ao prumo é feita por um sistema de aperto rápido aumentando a longevidade do prumo e a sua fácil e rápida substituição em caso de necessidade.

Tipo A – Sistema de fixação composto por base metálica embutida no solo e chumbada com betão;

Tipo B – Sistema de fixação composto por base metálica aparafusada ao solo;

Ferragens e acessórios

Ferragens: Aço zincado ou opcionalmente em aço inox A1 ou A2;

Cápsulas: Plástico polipropileno PP;

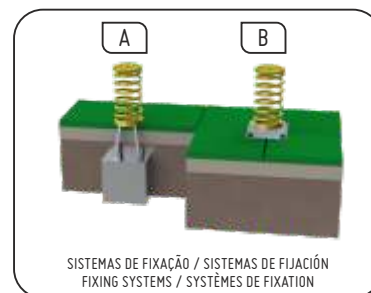

FUNÇÕES LÚDICAS/ FUNCIONES LÚDICAS / RECREATIONAL FUNCTIONS / FONCTIONS RÉCRÉATIVES



Divertir: Enquanto se divertem, as crianças adquirem imensas capacidades, desde habilidades físicas a interações sociais.



Socializar: A socialização e a imaginação são necessárias em todo o jogo. Tudo isso cria relação entre crianças e desperta o senso de convivência e a solidariedade.



Jogar: Desenvolve a paciência, a partilha e o espírito desportivo.



Baloiçar: Esta acção ajuda a desenvolver o equilíbrio da criança e lhe ensina como controlar os movimentos com o balanço certo e vigor, o que melhora a actividade psicomotora e coordenação do corpo.





Paneles

HDPE: Polietileno de alta densidad monocolor o bicolor, libre de HPA. Se trata de un polímero de extrema levedad y elasticidad, caracterizado por su resistencia a productos químicos, corrosión, rayos UV (UNE EN ISO 4892), alta resistencia a la inflamabilidad (UNE-EN ISO 11925-2) y resistencia a impactos (ISO 527-1). No necesita ningún tipo de mantenimiento.

Piezas Metálicas

Muelle: Muelle helicoidal en acero 35 SCD controlado en campo magnetoscópico;

Tubos:

Acero Inox: AISI 304 de acuerdo con la norma EN 1.4301.

Hierro: Acero carbono S235JR/S275, laminado en caliente.

Tratamientos de Superficies

Galvanización: Tratamiento anticorrosivo de galvanización por inmersión en caliente. Espesor entre 100 a 140µm de acuerdo con la norma EN ISO 1461.

Decapado: Proceso por chorro abrasivo para limpieza de la superficie metálica de oxidaciones e impurezas, garantizando un perfil de rugosidad ideal para el proceso de tratamiento de superficie; de acuerdo con la norma 8501:1;

Primario: La epoxi de poliéster anticorrosiva, ecológica con protección de nivel C4, con una cocción a 210°C;

Lacado: Pintura electrostática con pintura en polvo de poliéster con una cocción a 230°C, espesor entre 100 a 120µm, de acuerdo con la norma UNE EN ISO 2808;

Negativo

Fabricados en chapa de acero galvanizado, permiten su colocación sin que el poste entre en contacto directo con el suelo. Su fijación al poste se realiza a través de un sistema de apretado rápido aumentando la durabilidad del poste y su fácil y rápida sustitución en caso de necesidad.

Tipo A - Sistema de fijación estándar compuesto por una base metálica embutida en el suelo y relleno de hormigón.

Tipo B - Sistema de fijación estándar compuesto por pletina metálica atornillada a la base de hormigón.

Herrajes y Accesorios

Herrajes: Acero cincado u opcionalmente en acero inox A1 o A2.

Cápsulas: Plástico polipropileno PP.

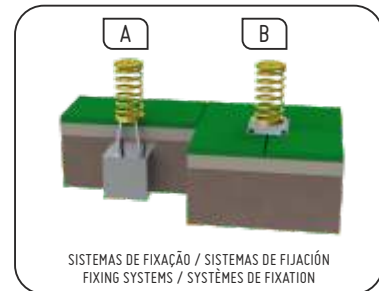

FUNÇÕES LÚDICAS/ FUNCIONES LÚDICAS / RECREATIONAL FUNCTIONS / FONCTIONS RÉCRÉATIVES



Divertir: Los niños, mientras se divierten, desarrollan una parte importante de sus capacidades, ya sean físicas, psicomotoras hasta interacciones sociales.



Socializar: Desarrollar la Socialización e imaginación son capacidades necesarias en los juegos de los niños; lo que conlleva a una relación interactiva entre ellos, despertando su sentido de convivencia y solidaridad.



Jugar: Desarrolla la tolerancia, el aprender a compartir, así como su espíritu deportivo.



Balaceo: Ayuda a desarrollar el equilibrio, y controlar los movimientos, estimulando de esta manera la psicomotricidad y coordinación en los niños





Panels

HDPE

High-density polyethylene mono or bicolour, free from HPA. It is a polymer of extreme lightness and elasticity characterized by resistance to chemicals, corrosion, UV rays (UNE EN ISO 4892), high resistance to flammability (UNE-EN ISO 11925-2) and resistance to impacts (ISO 527-1). It does not require any maintenance;

Metal Parts

Spring: Helical spring in 35 SCD steel controlled in magnetoscopic field;

Tubes

Pipes: Stainless steel: AISI 304 according to EN 1.4301;
Iron: S235JR / S275 carbon steel, hot rolled;

Surface Treatments

Galvanization: Anti-corrosion treatment of hot-dip galvanization between 100 and 140 µm, according to EN ISO 1461;
Pickling: Abrasive jet process for cleaning the metal surface from oxidation and impurities, ensuring an ideal roughness profile for the surface treatment process; according to standard 8501: 1;
Primer: Ecological anti-corrosion polyester epoxy with protection level C4, with cooking at 210°C;
Powder Coating: Electrostatic painting in polyester powder paint with 230°C cooking, thickness between 100 to 120µm, according to UNE EN ISO 2808;

Anchoring

Made of galvanized steel sheet, they can be installed without the post coming into direct contact with the ground. Its fixation to the post is made by a quick clamping system increasing the longevity of the post and its easy and quick replacement if necessary.

Type A: Fixing system consisting of a metal base embedded in the ground and anchored with concrete;

Type B: Fixing system made up of a metal base screwed to the ground;

Hardware and accessories

Hardware: Galvanized steel or optionally A1 or A2 stainless steel;
Capsules: PP polypropylene plastic;

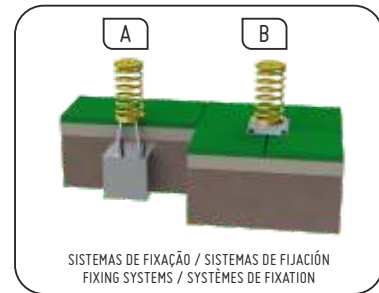

FUNÇÕES LÚDICAS/ FUNCIONES LÚDICAS / RECREATIONAL FUNCTIONS / FONCTIONS RÉCRÉATIVES



Fun: While having fun, children acquire immense abilities, from physical abilities to social interactions.



Socialize: Socialization and imagination are necessary throughout the game. All this creates a relationship between children and awakens the sense of coexistence and solidarity.



Play: Develops patience, sharing and sporting spirit.



Swing: This action helps to develop the child's balance and teaches you how to control movements with the right balance and vigor, which improves the psychomotor activity and coordination of the body.



Panneaux

HDPE: Mono-couleur, bicolore, polyéthylène haute densité, sans HPA. C'est un polymère d'une extrême légèreté et élasticité caractérisé par une résistance aux produits chimiques, à la corrosion, aux rayons UV (UNE EN ISO 4892), une haute résistance à l'inflammabilité (UNE-EN ISO 11925-2) et une résistance aux chocs (ISO 527-1). Il ne nécessite aucun entretien;

Pièces Métalliques

Ressort : ressort hélicoïdal en acier 35 SCD contrôlé en champ magnétoscopique;

Tubes

Acier inoxydable : AISI 304 selon EN 1.4301;

Fer : acier au carbone S235JR / S275, laminé à chaud;

Traitements de surface

Galvanisation : Traitement anti-corrosion de la galvanisation à chaud entre 100 et 140 µm selon EN ISO 1461.

Décapage : Procédé par jet abrasif pour nettoyer la surface métallique de l'oxydation et des impuretés, assurant un profil de rugosité idéal pour le processus de traitement de surface; selon la norme 8501:1;

Primaire : Epoxy polyester anti-corrosion écologique avec niveau de protection C4, avec cuisson à 210°C;

Laquage : Peinture électrostatique en peinture poudre polyester avec cuisson 230°C, épaisseur entre 100 et 120µm, selon UNE EN ISO 2808;

Négatif

Fabriqués en tôle d'acier galvanisé, ils peuvent être installés sans que le fil à plomb n'entre en contact direct avec le sol. Sa fixation au fil à plomb est réalisée par un système de serrage rapide augmentant la longévité du fil à plomb et son remplacement facile et rapide si nécessaire.

Type A - Système de fixation composé d'une base métallique sceller dans le sol et ancrée avec du béton;

Type B - Système de fixation composé d'une base métallique vissée au sol;

Quincaillerie et accessoires

Matériel : acier galvanisé ou éventuellement acier inoxydable A1 ou A2;

Capsules : plastique polypropylène PP;

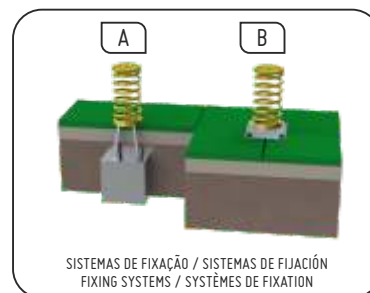

■ ■ FUNÇÕES LÚDICAS/ FUNCIONES LÚDICAS / RECREATIONAL FUNCTIONS / FONCTIONS RÉCRÉATIVES



Amuser: tout en s'amusant, les enfants acquièrent d'énormes capacités, allant des capacités physiques aux interactions sociales.



Socialiser: la socialisation et l'imagination sont nécessaires tout au long du jeu. Tout cela crée une relation entre les enfants et éveille le sentiment de coexistence et de solidarité.



Jouer: Développe la patience, le partage et l'esprit sportif.



Swing: Cette action aide à développer l'équilibre de l'enfant et vous apprend à contrôler les mouvements avec le bon équilibre et la bonne vigueur, ce qui améliore l'activité psychomotrice et la coordination du corps.