

SALTO

BCMC010

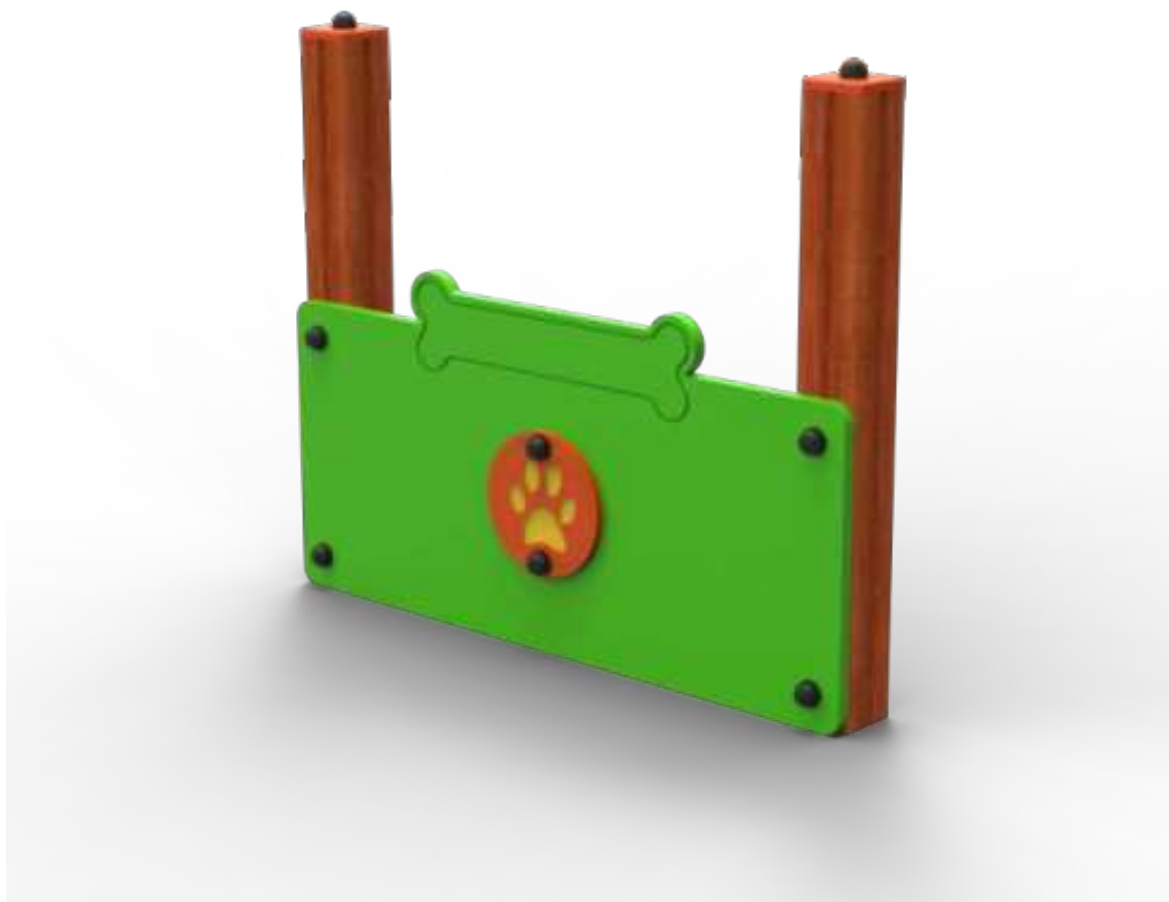



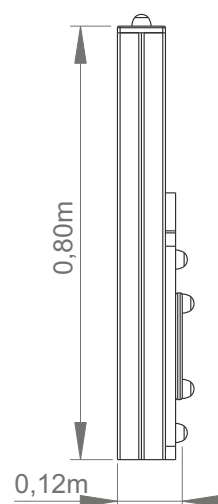
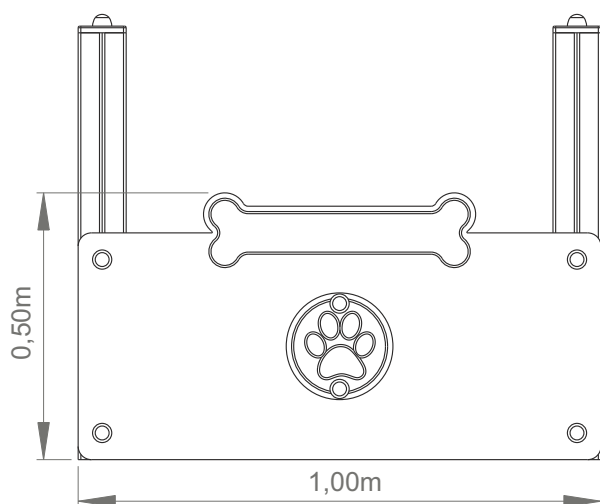

 13m^2 0.80m



Utilização do equipamento sujeito a condições vigiadas; Zona de segurança: Área mínima requerida pela norma EN 1176-1,6
 Utilización del equipo sujeto a condiciones vigiladas; Zona de seguridad: Área mínima requerida por la norma EN 1176-1,6
 Use of equipment subject to supervised conditions; Safety zone: Minimum area required by EN 1176-1,6
 Utilisation d'équipement soumis à des conditions supervisées; Zone de sécurité: Surface minimale requise par l'EN 1176-1,6



| | |
|---|------|
| | 1 |
|  | 0,80 |
|  | 13 |
| | 13 |

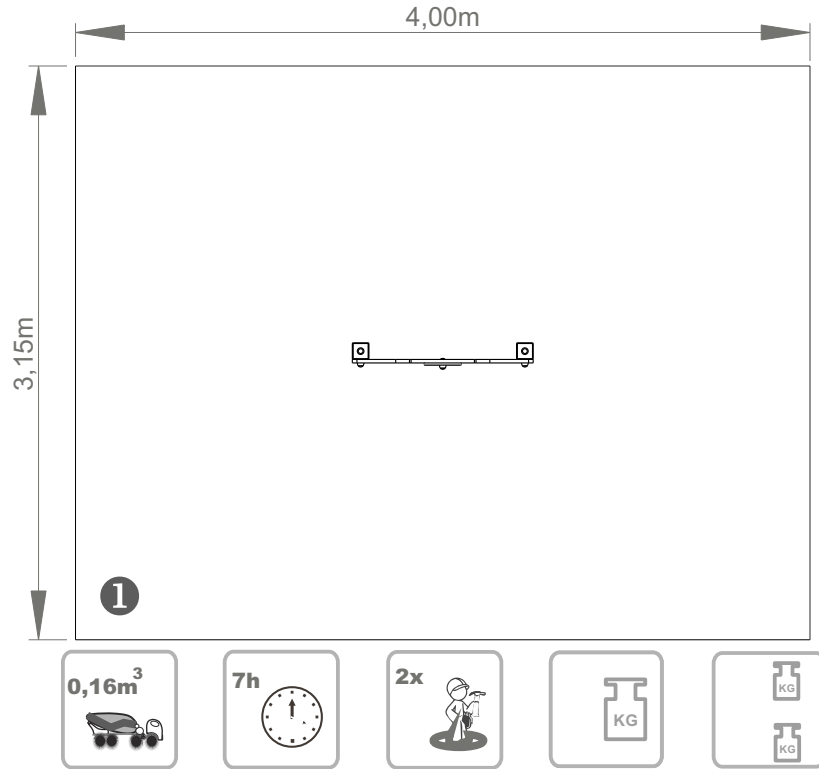

INFORMAÇÃO TÉCNICA / INFORMACIÓN TÉCNICA / TECHNICAL INFORMATION / INFORMATIONS TECHNIQUES

1 - Salto  1.20m

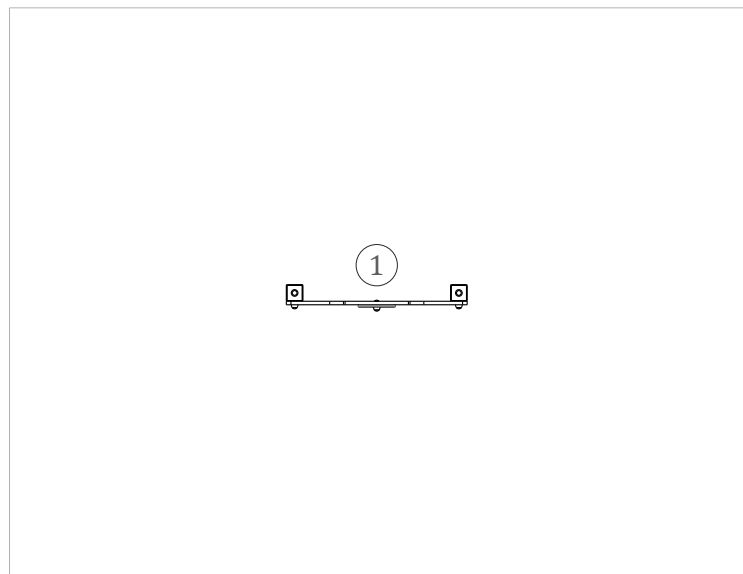



Prumo

Madeira: Pinho laminado classificado com qualidade de garantia por controlo interno contínuo. Com tratamento autoclave, protegendo-a dos ataques de cogumelos, insectos e térmites. Acabamento final a tinta de base aquosa especialmente desenvolvida para proteger a madeira de humidades, intempéries e raios U.V.. Contém princípios activos que lhe conferem uma barreira protetora contra o aparecimento de fungos e bolores;

Painel

HDPE: Polietileno de alta densidade monocolor ou bicolor. Por ser um polímero é caracterizado pela sua resistência a produtos químicos e à corrosão. Pela sua capacidade de elasticidade e leveza, oferece alta resistência ao impacto, sendo muito difícil quebrar. A sua base sintética impede o cultivo de bactérias e fungos. Não necessita de qualquer manutenção;

Sistema de fixação

Tipo C – Sistema de fixação standard composto por prumo aplicado directamente no solo e chumbado com betão;

Parafusos e acessórios

Parafusos: Aço zincado ou opcionalmente aço inox AISI 304;

Cápsulas: Plástico polipropileno PP;



PROTECTORES DECORATIVOS:



Penetra profundamente na madeira destacando os veios e embelezando a madeira com os seus cores especiais transparentes



Muito resistente ao sol. Contém pigmentos micronizados absorventes e estabilizadores dos raios U.V.



Microporosos, deixa respirar a madeira e evita as deformações naturais da madeira.



Fácil manutenção. Não é necessário lixar ou decapar para a aplicação de novas camadas.



PRINCÍPIOS ACTIVOS
Conferindo ao filme uma barreira protectora contra fungos e bolores



HIDRÓFUGO
protege contra a humidade, a chuva e impermeabiliza.





Postes

Madera: Pino laminado clasificado con calidad de garantía por control interno continuo. Con tratamiento autoclave, protegiéndola de los ataques de setas, insectos y termitas. Acabado final a tinta de base acuosa especialmente desarrollada para proteger la madera de humedad, intemperie y rayos U.V .. Contiene principios activos que le confieren una barrera protectora contra la aparición de hongos y mohos;

panel

HDPE: Polietileno de alta densidad monocolor o bicolor. Por ser un polímero se caracteriza por su resistencia a los productos químicos y a la corrosión. Por su capacidad de elasticidad y ligereza, ofrece alta resistencia al impacto, siendo muy difícil romper. Su base sintética impide el cultivo de bacterias y hongos. No necesita mantenimiento;

Sistema de fijación

Tipo C – Sistema de fijación estándar compuesto por pluma aplicada directamente en el suelo y plomado con hormigón;

Tornillos y accesorios

Tornillos: Acero zincado o opcionalmente acero inoxidable AISI 304;
Cápsulas: Plástico polipropileno PP;



PROTECTORES DECORATIVOS:



Penetra profundamente en la madera destacando los vetas y embellecer la madera con los sus colores especiales transparentes



Muy resistente al sol, contiene pigmentos micronizados absorbentes y estabilizadores de los rayos U.V



Microporoso, deja respirar la madera y evita las deformaciones naturales de la madera.



Fácil mantenimiento. No es necesario lijar o decapar para la aplicación de nuevas capas.



que le da a la película una barrera protectora contra los hongos y los mohos



protege contra la humedad, la lluvia e impermeabiliza.





Plums

Wood: Laminated pine classified with guarantee quality by continuous internal control. With autoclave treatment, protecting it from attacks of mushrooms, insects and termites. Water-based paint finish specially developed to protect wood from moisture, weather and U.V. rays. Contains active principles that give it a protective barrier against the appearance of fungi and molds;

Panel

HDPE: High density polyethylene mono or two color. Being a polymer is characterized by its resistance to chemicals and corrosion. Due to its elasticity and lightness, it offers high impact resistance and is very difficult to break. Its synthetic base prevents the cultivation of bacteria and fungi. It does not require any maintenance;

Fixation System

Type C – Standard fixing system composed of plumbing applied directly to the ground and cast with concrete;







Screws and accessories

Screws: Zinc-plated steel or optionally AISI 304 stainless steel;

Capsules: PP polypropylene plastic;



 **DECORATIVE PROTECTORS:**

| | | |
|---|---|---|
|  Penetrates deep into wood highlighting and embellishing the wood with their special transparent colors |  Very resistant to sun. Contains absorbent micronized pigments and UV stabilizers. |  Microporous, let the wood breathe and prevents the natural deformations of the wood. |
|  Easy maintenance. No sanding or pickling is required for the application of new layers. | <p>ACTIVE PRINCIPLES</p>  Giving the film a protective barrier against fungi and molds | <p>WATER-REPELLENT</p>  protects against moisture, rain and waterproof. |

C



SISTEMAS DE FIXAÇÃO / SISTEMAS DE FIJACIÓN
FIXING SYSTEMS / SYSTÈMES DE FIXATION

Poteaux

Bois: Pin stratifié classé avec une qualité garantie par contrôle interne continu. Avec traitement autoclave, le protégeant des attaques de champignons, d'insectes et de termites. Finition de peinture à base d'eau spécialement développée pour protéger le bois contre l'humidité, les intempéries et les rayons UV. Contient des principes actifs qui lui confèrent une barrière protectrice contre l'apparition de champignons et de moisissures;

Panneau

HDPE: Polyéthylène haute densité mono ou bicolore. Être un polymère se caractérise par sa résistance aux produits chimiques et à la corrosion. Grâce à son élasticité et à sa légèreté, il offre une grande résistance aux chocs et est très difficile à briser. Sa base synthétique empêche la culture de bactéries et de champignons. Il ne nécessite aucun entretien

Système de fixation

Type C – Système de fixation standard composé de plomberie appliquée directement sur le sol et coulée avec du béton;

Vis et accessoires





Vis: Acier zingué ou acier inoxydable AISI 304 en option;

Capsules: PP polypropylène plastique;



100%

 **PROTECTEURS DÉCORATIFS:**

| | | |
|--|--|---|
|  <p>Pénètre profondément dans le bois en soulignant les veines et en embellissant le bois avec ses couleurs transparentes spéciales</p> |  <p>Très résistant au soleil il contient des pigments micronisés d'absorption des stabilisants UV.</p> <p>PRINCIPES ACTIFS</p>  <p>Donnant au film une barrière protectrice contre les champignons et les moisissures</p> |  <p>Microporeux, laisse respirer le bois et empêche les déformations naturelles du bois.</p> <p>HYDROFUGUE</p>  <p>protège contre l'humidité, la pluie et imperméable.</p> |
|--|--|---|

C



SISTEMAS DE FIXAÇÃO / SISTEMAS DE FIJACIÓN
FIXING SYSTEMS / SYSTÈMES DE FIXATION